

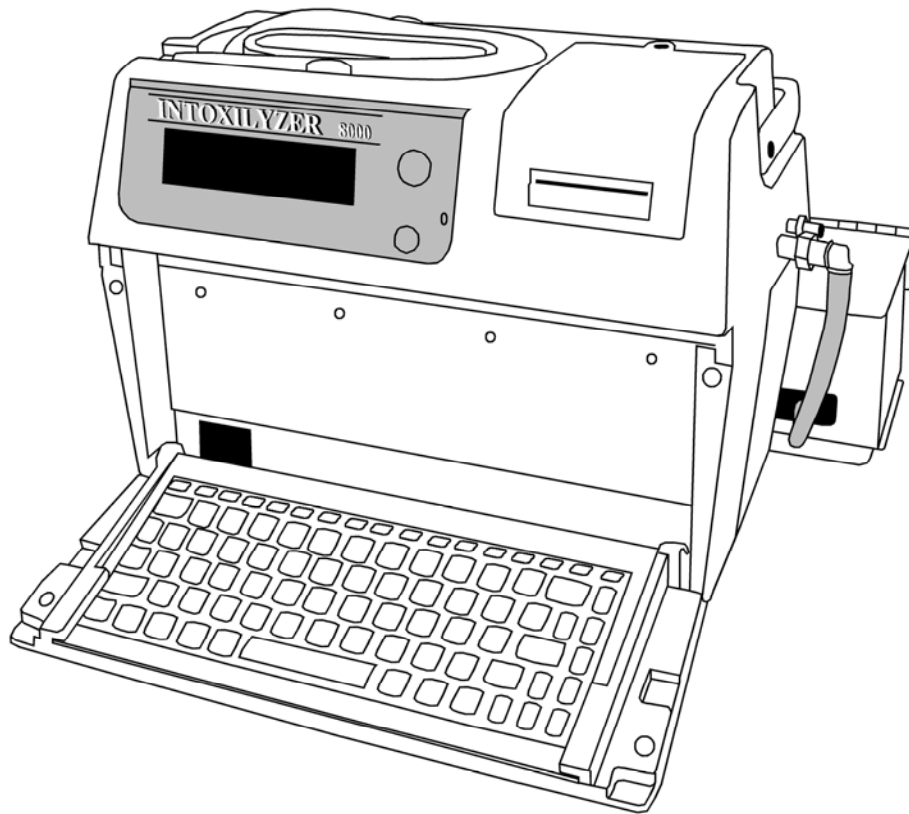

**OREGON STATE POLICE
FORENSIC SERVICES DIVISION**

OPERATION GUIDE



INTOXILYZER 8000[®] OPERATOR'S GUIDE

OREGON STATE POLICE IMPLIED CONSENT PROGRAM

INTOXILYZER 8000 OPERATOR'S GUIDE
TABLE OF CONTENTS

INTRODUCTION3

1.0 GETTING STARTED5

The Intoxilyzer 8000 Breath Alcohol Analyzer System 5

The Intoxilyzer 8000 Breath Alcohol Analyzer 5

Turning the Instrument Power On & Off..... 7

Instrument Warm-Up Period 7

External Printer 8

Printer LED Indications 9

2.0 STEP ONE – PREPARING TO CONDUCT A TEST10

The Operator’s Checklist 10

Pre-test Observation Period..... 10

Instrument Set-up 10

Press the “Start Test” button..... 11

Selecting a Test Method 11

Entering Permit Data Manually 12

Entering an Operator PIN 13

Scanning a Driver’s License 13

Entering Driver’s License Data Manually 14

Reviewing Data 15

3.0 STEP TWO – CONDUCTING A BREATH TEST17

Testing Sequence 17

The "Ready in 00:XX" message..... 17

Air Blank..... 18

Diagnostic Routine..... 18

Air Blank..... 19

Breath Sampling Period 19

Air Blank..... 22

Continued Observation Period..... 23

Air Blank..... 24

Breath Sampling Period 24

Air Blank..... 28

Control Sample 28

Air Blank..... 29

Comment Lines..... 29

Printing of the Test Report 30

Subject Sample Agreement 31

Originally Adopted: 07/13/2006

Revision #: 1.0
Revision Effective Date: 07/17/2006

OREGON STATE POLICE IMPLIED CONSENT PROGRAM

INTOXILYZER 8000 OPERATOR'S GUIDE
TABLE OF CONTENTS

4.0 STEP THREE – REVIEWING THE TEST REPORT32
The Test Report 32
Complete Test Reports 32
Incomplete Test Reports 33
Common Exception Messages: 33
Suggested Corrective Action Statements 39
Other Messages Displayed by the Instrument 39

5.0 REPRINTING THE TEST REPORT42
Requesting Copies of Test Reports 42
On-site Reprinting of Test Reports 42
Entering Permit Data Manually 42
Entering an Operator PIN 43
Selection of a Test Report for Reprinting 44

6.0 CONDUCTING A JAIL RELEASE TEST45
Conducting a Jail Release Test 45
The "Ready in 00:XX" message 45
Air Blank 45
Breath Sampling Period 46
Air Blank 48

7.0 PLACING AN INSTRUMENT OUT-OF-SERVICE49

APPENDIX A: OPERATOR'S CHECKLIST50

Originally Adopted: 07/13/2006

Revision #: 1.0
Revision Effective Date: 07/17/2006

OREGON STATE POLICE IMPLIED CONSENT PROGRAM

**INTOXILYZER 8000 OPERATOR'S GUIDE
INTRODUCTION**

INTRODUCTION

Intoxicated drivers have been, and still are, the major cause of traffic fatalities in the State of Oregon since the introduction of the automobile. The intoxicated driver is not limited to the interstate or state highways, but can be found on every city street and county road in the state. For law enforcement officers, the problem of the intoxicated driver is a source of major concern.

Operators constitute the cornerstone of any breath alcohol testing program. Conscientious operators, confident in their abilities and competent with the equipment, form the foundation of a solid program. Careless operators, unfamiliar with the operation of the equipment, generate judicial apprehension, as do competent operators that attempt to present expert testimony in excess of their background, training, and capabilities.

The Oregon State Police Intoxilyzer 8000 Operator's Guide is prepared by the Forensic Services Division and is designed to provide qualified operators with a quick reference guide to the operation of the Intoxilyzer 8000 breath-alcohol analyzer. This guide aims to improve the quality of breath alcohol analyses conducted in Oregon by promoting and maintaining consistency and quality among Intoxilyzer 8000 operators. This Guide will serve as a good reference for the operation of the Intoxilyzer 8000 instrument. You should read this guide and refer to it as needed.

For additional information, consult the following web address:

<http://egov.oregon.gov/osp/forensics/lawenfresources.shtml>

Organization of the Guide

The organization and content of this guide has been minimized to facilitate the quick and easy access of reference information for the operator. It covers the steps necessary to successfully complete an evidential breath analysis, a jail release breath analysis, and event exception messages for the Intoxilyzer 8000 instrument.

Disclaimer

Information contained in this guide is made available as a service for training law enforcement personnel only. It does not constitute or represent an official record of the Office of the Legislative Counsel. The Oregon State Police, its offices, and employees make no warranty as to the accuracy, reliability, or completeness of any statutory or Oregon case-law information contained herein and are not responsible for any errors or omissions for results obtained from the use or misuse of this information. Any additional inquiries regarding statutory or case-law interpretation should be addressed to your local district attorney's office.

CMI and INTOXILYZER are registered trademarks of CMI, Inc.

	Originally Adopted: 07/13/2006	Revision #: 1.0 Revision Effective Date: 07/17/2006
ALL PRINTED COPIES ARE UNCONTROLLED AND MAY NOT BE COMPLETE		Page 3 of 50

OREGON STATE POLICE IMPLIED CONSENT PROGRAM

**INTOXILYZER 8000 OPERATOR'S GUIDE
INTRODUCTION**

Acknowledgments

The author recognizes efforts of the following individuals and groups for their contributions to this manual:

- Department of Public Safety Standards and Training
- Oregon State Police Drug Recognition Program
- Implied Consent Program / Drug Recognition Program Advisory Committee
- Oregon State Police Toxicology/Implied Consent Section
- CMI, Inc.

Originally Adopted: 07/13/2006

Revision #: 1.0
Revision Effective Date: 07/17/2006

ALL PRINTED COPIES ARE UNCONTROLLED AND MAY NOT BE COMPLETE

Page 4 of 50

INTOXILYZER 8000 OPERATOR'S GUIDE
1.0 GETTING STARTED

1.0 GETTING STARTED

WARNING

DO NOT TURN THE POWER OFF TO THE INSTRUMENT, UNPLUG THE INSTRUMENT, OR DISCONNECT ANY OF THE CABLES ATTACHED TO THE INSTRUMENT UNLESS UNDER DIRECTION BY A TRAINED TECHNICIAN OF THE OREGON STATE POLICE.

The Intoxilyzer 8000 Breath Alcohol Analyzer System

The Intoxilyzer 8000 breath alcohol analyzer system is a micro-processor controlled infrared-based breath alcohol testing device. For purposes of this guide, the System consists of two (2) primary components: 1) the Intoxilyzer 8000 instrument, and 2) the external printer. Because the instrument is micro-processor controlled, certain steps should be followed to ensure that a proper analysis is performed. This segment will familiarize you with the different components, controls, and indicators of the Intoxilyzer 8000 and provide a brief explanation for each.

The Intoxilyzer 8000 Breath Alcohol Analyzer

Figure 1 explains the parts, controls, and indicators of the Intoxilyzer 8000:

Figure 1a. Intoxilyzer 8000 Parts, Controls, and Indicators (front)

- 1 Instrument fluorescent display
- 2 Start Test button
- 3 Power indicator
- 4 Bar code scanner
- 5 Keyboard (PS/2)

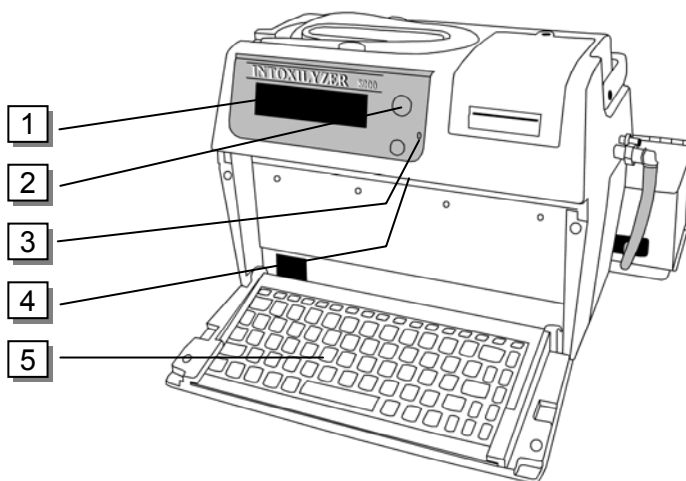

INTOXILYZER 8000 OPERATOR'S GUIDE
1.0 GETTING STARTED

Figure 1b. Intoxilyzer 8000 Parts, Controls, and Indicators (top)

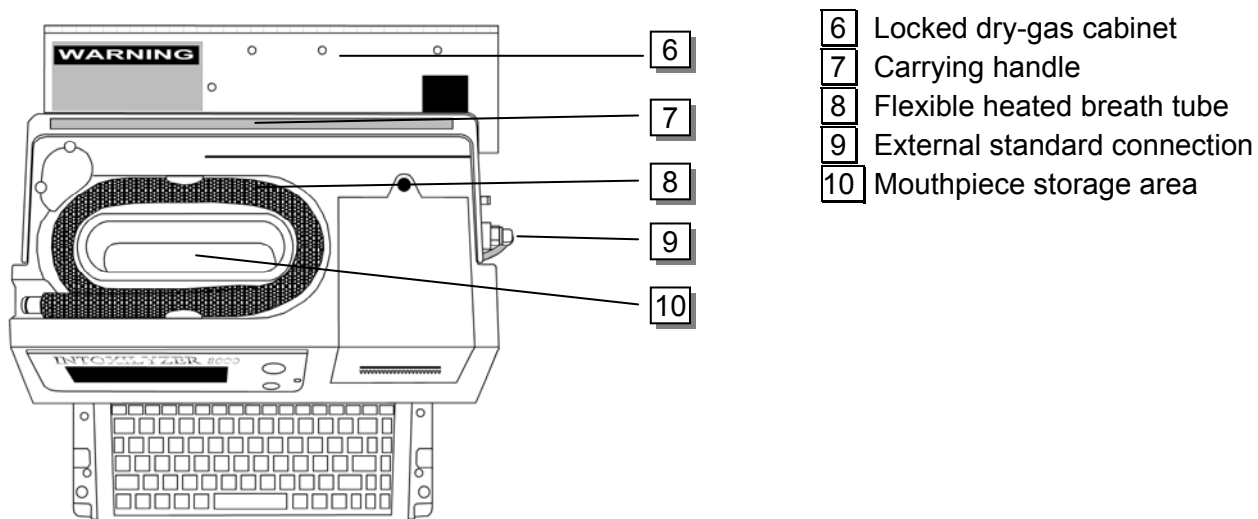
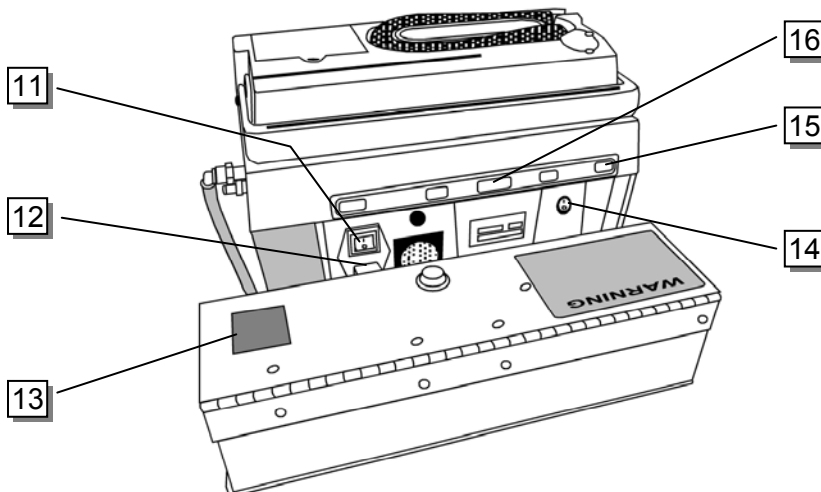

Figure 1c. Intoxilyzer 8000 Parts, Controls, and Indicators (back)



- 11 Main AC power switch (rocker-switch)
- 12 AC Power cord
- 13 Dry-gas regulator/pressure view port
- 14 Battery power switch (rocker-switch)
- 15 Modem Line Connection (RJ-11)
- 16 External Printer Connection (25-pin)

INTOXILYZER 8000 OPERATOR'S GUIDE
1.0 GETTING STARTED

Turning the Instrument Power On & Off

The Intoxilyzer 8000 has two on/off power switches located on the back of the instrument: one switch operates the main AC power and the second switch operates the on-board battery back-up system. To power the instrument ON, both the main AC power switch and the battery power switch must be in the ON (UP) position for the instrument to run on AC power. The instrument's power can appear to be ON when only the battery switch is in the ON (UP) position, however, the instrument is not operating on AC power in this condition. It is recommended that the main AC power switch be placed in the ON (UP) position first followed by the batter power switch. When the instrument power is turned ON and operating on AC power, the LED Power Indicator light on the front of the instrument will be a "green" or "amber" color. The "amber" color indicates the battery is charging. The "green" color indicates the battery is not charging (i.e., fully charged) or only AC power is available.

To turn the instrument's power OFF, both the main AC power switch and the battery power switch must be placed in the off (down) position. It is recommended that the battery power switch be placed in the OFF (DOWN) position first followed by the main AC power switch.

To operate the instrument using the on-board back-up battery system, place the main AC power switch in the OFF (DOWN) position and place the battery power switch in the ON (UP) position. Although the instrument will operate in this mode, the length of time that the instrument can be used is limited to approximately two (2) hours. It is recommended that the instrument be used with the main AC power switch in the ON (UP) position to ensure that the instrument will not power OFF during a test sequence. If the instrument is allowed to remain ON in battery mode, the instrument will eventually generate an audible warning tone when the battery power becomes too low.

Instrument Warm-Up Period

When initially powering the instrument from an unheated condition, the instrument will require approximately twenty-minutes to warm-up prior to displaying the "Ready to Start" message. During this time, the instrument can not be used by the operator to perform a breath test sequence. The operator will know that the instrument has completed the warm-up period and is ready to perform a breath test when the instrument display reads "Ready to Start".

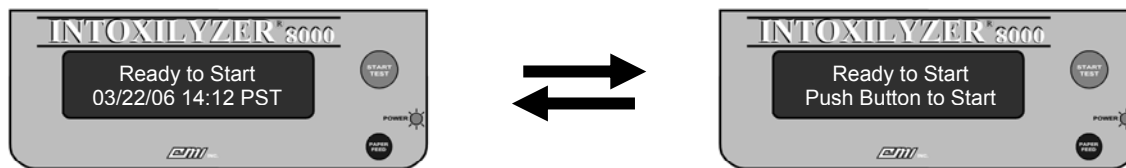

	Originally Adopted: 07/13/2006	Revision #: 1.0 Revision Effective Date: 07/17/2006
ALL PRINTED COPIES ARE UNCONTROLLED AND MAY NOT BE COMPLETE		Page 7 of 50

INTOXILYZER 8000 OPERATOR'S GUIDE
1.0 GETTING STARTED

External Printer

NOTE

The brand and/or model of the external printer that is attached to the instrument is not important to the performance (accuracy or reliability) of the Intoxilyzer 8000 instrument. Any PCL 6 (Printer Command Language v6) compatible printer may be used with the instrument.

Figure 2 explains the parts, controls, and indicators of the external printer (Brother HL-5250DN). If a different model of printer is attached to the instrument, refer to the operator's guide for that specific model of printer.

Figure 2a. Brother HL-5250DN Parts, Controls, and Indicators (front)

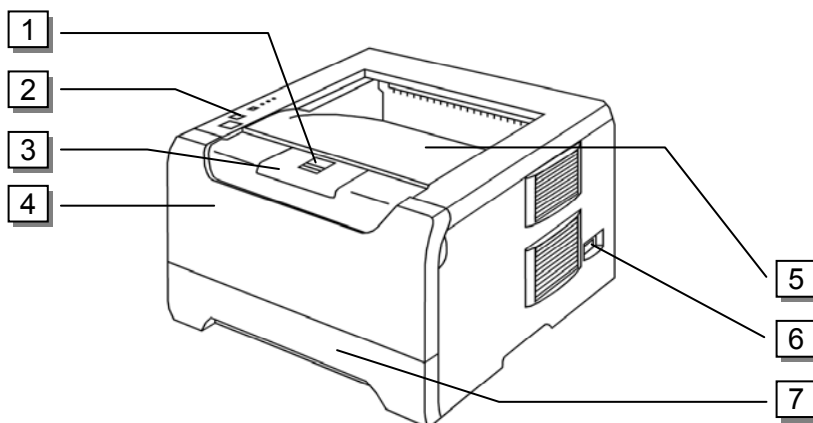

- 1 Front Cover Release Button (toner cartridge access)
- 2 Control panel
- 3 Face-down output tray support flap

- 4 Front cover (multi-purpose tray)
- 5 Face-down output tray
- 6 AC power switch
- 7 Paper tray

OREGON STATE POLICE IMPLIED CONSENT PROGRAM

**INTOXILYZER 8000 OPERATOR'S GUIDE
1.0 GETTING STARTED**

Figure 2a. Brother HL-5250DN Parts, Controls, and Indicators (control panel)

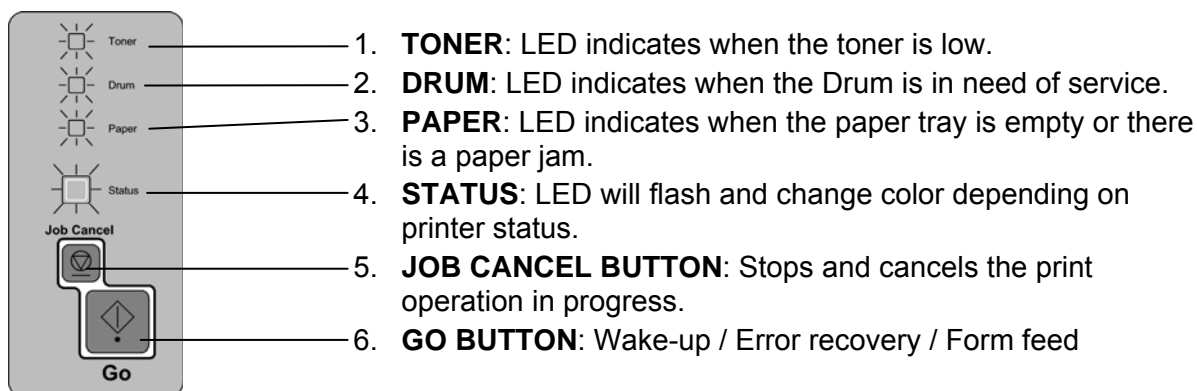

Printer LED Indications

The following table explains the various LED indications provided by the Brother HL-5250DN printer:

- ★: Blinking
- : On
- : Off

Printer LED	Sleep / Off	Warming Up Cooling Down	Ready	Receiving Data	Print Data Remaining
Toner	□	□	□	□	□
Drum	□	□	□	□	□
Paper	□	□	□	□	□
Status	□	★ Green ¹	■ Green	★ Yellow ¹	■ Yellow

Printer LED	Toner Low	Toner Service	Drum Service	Cover Open	No Paper or Paper jam	Service Call
Toner	■ Yellow ²	■ Yellow	□	□	□	■ Yellow ¹
Drum	□	□	■ Yellow ²	□	□	■ Yellow ¹
Paper	□	□	□	□	■ Yellow ¹	■ Yellow ¹
Status	■ Green	■ Red	■ Green	■ Red	■ Red	★ Red ¹

¹ The LED will blink fast.

² The LED will blink in a pattern of ON for 2 seconds and then OFF for 3 seconds.

INTOXILYZER 8000 OPERATOR'S GUIDE
2.0 STEP ONE – PREPARING TO CONDUCT A TEST

2.0 STEP ONE – PREPARING TO CONDUCT A TEST

The Operator's Checklist

When preparing to conduct a breath test, it is helpful for the operator to know which Test Sequence they intend to utilize (see section on **Selecting a Test Method** below). If the operator intends to conduct a Jail Release Test, there is no need to make use of an Intoxilyzer 8000 Operator's Checklist. In all other cases, it may be helpful for an operator to take advantage of the Operator Checklist. To obtain a checklist, the operator may press the "F2" key on the instrument keyboard. Although strongly recommended, use of an Operator's Checklist by the operator is not required to successfully complete the testing process. A sample checklist is also contained as Appendix A in this guide.

Pre-test Observation Period

The first and most important step in the breath testing process is the Pre-test Observation Period. The Pre-test Observation Period should be conducted on all subjects prior to any breath test and must be conducted on all subjects being tested in non-Jail Release testing situations. The subject is not allowed to vomit, regurgitate, eat, drink, smoke, chew or take anything orally for at least fifteen minutes prior to submitting the breath sample. This is to ensure there is no possibility of residual alcohol or mouth contamination causing a result that does not reflect the subject's true blood alcohol concentration. The Intoxilyzer does monitor the breath sample throughout the entire delivery and will automatically abort the testing sequence if any abnormalities are detected. By observing the fifteen minute observation period, however, the possibility of residual mouth alcohol contamination is eliminated. The Pre-Test Observation Period is recommended when using the Jail Release Test Sequence and required in all other testing situations.

Instrument Set-up

Prior to starting the breath testing sequence, the operator should check the instrument power indicator to ensure that the instrument power is turned on. This instrument display will be flashing and displaying the "Ready to Start" message:

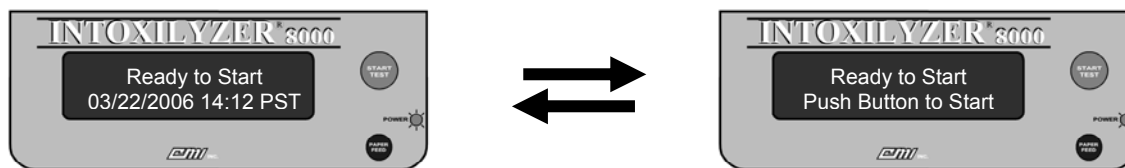

With the instrument in a Ready to Start mode, the operator should note that the time and date are correct. If the time and/or date are incorrect, the operator should write in the proper time and/or date of the analysis on the completed evidence card and then notify the Oregon State Police Implied Consent Unit to have the date/time corrected. The time and date are a completely separate system in the instrument, and the fact that the time or date may be incorrect has absolutely no effect on the accuracy and validity of the test result.

	Originally Adopted: 07/13/2006	Revision #: 1.0 Revision Effective Date: 07/17/2006
ALL PRINTED COPIES ARE UNCONTROLLED AND MAY NOT BE COMPLETE		Page 10 of 50

OREGON STATE POLICE IMPLIED CONSENT PROGRAM

INTOXILYZER 8000 OPERATOR'S GUIDE
2.0 STEP ONE – PREPARING TO CONDUCT A TEST

Press the “Start Test” button

To initiate the test sequence the operator need only push the green “Start Test” button. The instrument will acknowledge the operator’s request to start a test by updating the instrument display to the “**Jail Release (Y/N)?**” message.

Selecting a Test Method

From the “**Jail Release (Y/N)?**” display, the operator should select either “Y” or “N” using the instrument’s keyboard. The instrument default selection is set to answer this question “no”, and the letter “N” is displayed on the second line of the display to indicate the selection. The operator must confirm the selection by pressing the “Enter” key on the instrument’s keyboard.



The operator should select “Y” in all instances where it is desired to evaluate a person’s blood alcohol level for the purpose of determining the person’s eligibility for release from a jail (detox) or other detention facility. The instrument will acknowledge the operator’s selection to conduct a jail release test by updating the instrument display and proceeding to the “**Ready in 00:XX**” message, where the 00:XX message will display a period of time, generally less than 60 seconds. The operator should refer to the next section for more information (refer to **Section 6.0 – Conducting a Jail Release Test**).

The operator should select “N” in all other instances. The instrument will acknowledge the operator’s selection by updating the instrument display to the “**Scan Operator Permit or Press Enter**” message.

Scanning a Permit

When the instrument displays the “**Scan Operator Permit or Press Enter**” message, the operator may use the instrument’s internal bar code scanner to read the bar code printed on an operator permit card.



The card should be held perpendicular to the face of the instrument directly above the keyboard. The card should be kept as flat as possible and held still until the instrument reads the bar code printed on

	Originally Adopted: 07/13/2006	Revision #: 1.0 Revision Effective Date: 07/17/2006
ALL PRINTED COPIES ARE UNCONTROLLED AND MAY NOT BE COMPLETE		Page 11 of 50

OREGON STATE POLICE IMPLIED CONSENT PROGRAM

INTOXILYZER 8000 OPERATOR'S GUIDE
2.0 STEP ONE – PREPARING TO CONDUCT A TEST

the card. The operator will have approximately 30 seconds to complete the scanning process or the instrument will default to manual entry and display the “Enter Permit #” message. The instrument will acknowledge that a successful scan of the operator’s card was completed by alerting the operator with an audible tone. The instrument will then proceed to the “Enter Operator PIN” message (see Entering an Operator PIN).

Entering Permit Data Manually

From the “Scan Operator Permit or Press Enter” message, the operator may choose to enter their operator permit information manually by pressing the “Enter” key on the instrument’s keyboard. An operator may choose to do this in the event that they have forgotten or lost their operator permit card, or in the event that the bar code printed on the operator permit card is unreadable by the instrument’s bar code scanner. The instrument will acknowledge the operator’s selection to manually enter permit information by proceeding to the “Enter Permit #” message.



The operator should type in his or her operator permit number (DPSST number). As the operator enters information on the keyboard, the information will be displayed on the second line of the instrument’s display. The operator must then confirm the permit information by pressing the “Enter” key on the instrument’s keyboard. **IN ORDER TO START THE TESTING SEQUENCE, A VALID OPERATOR PERMIT NUMBER AND PIN COMBINATION MUST BE ENTERED. THE OPERATOR CANNOT CHOOSE TO SKIP THESE STEPS.** Following entry of the operator permit number, the instrument will proceed to the “Enter Operator Name (Last, First, M)” message. If no permit number is entered, the instrument will return to the “Ready to Start” message after approximately 60 seconds have elapsed. The instrument will abort the testing sequence if an invalid permit number and PIN combination are entered. The “Enter Operator Name (Last, First, M)” message will look similar to the following:



The operator should type his or her name just as it is to be printed on the final Completed Test Report. As the operator enters information on the keyboard, the information will be displayed on the second line of the instrument’s display. Generally, name information is entered in a uniform format similar to that used by the LEADS (Law Enforcement Data System) reporting system (last name, first

	Originally Adopted: 07/13/2006	Revision #: 1.0 Revision Effective Date: 07/17/2006
ALL PRINTED COPIES ARE UNCONTROLLED AND MAY NOT BE COMPLETE		Page 12 of 50

INTOXILYZER 8000 OPERATOR'S GUIDE
2.0 STEP ONE – PREPARING TO CONDUCT A TEST

name, middle name or initial), however, the operator name field is not required and no data need be entered for the instrument to proceed through the testing sequence. Information entered into the instrument will be printed on the Test Report in WYSIWYG (What You See Is What You Get) format. The operator must confirm the information entered by pressing the “Enter” key on the instrument’s keyboard. The instrument will then proceed to the **“Enter Operator PIN”** message.

Entering an Operator PIN

Upon successfully scanning an operator permit or the manual entry of a valid permit number and operator name, the instrument will proceed to the **“Enter Operator PIN”** message. The operator should enter his or her Personal Identification Number (PIN) and confirm the information by pressing the “Enter” key on the instrument’s keyboard:

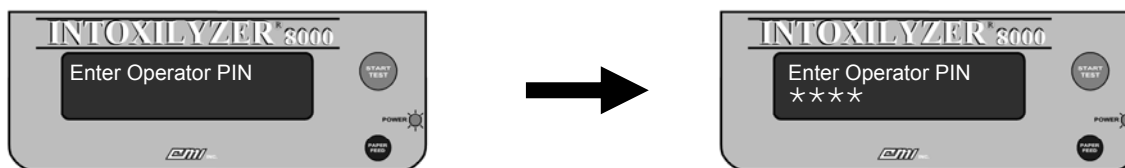

As the operator enters his or her PIN information on the keyboard, an asterisk (“*”) character will be displayed on the second line of the instrument’s display. The instrument will validate the information provided by the operator and acknowledge that a valid PIN has been entered by proceeding to the **“Scan Subject License or Press Enter”** message. If an operator does not enter his/her correct PIN, the instrument will abort the testing sequence after three (3) unsuccessful attempts are made by the operator. If a PIN is not successfully entered, or no PIN is entered, the instrument will return to the **“Ready to Start”** message after approximately 60 seconds have elapsed.

Scanning a Driver’s License

When the instrument displays the **“Scan Subject License or Press Enter”** message, the operator may use the instrument’s internal bar code scanner to read the bar code printed on a driver’s license.



The card should be held perpendicular to the face of the instrument directly above the keyboard. The card should be kept as flat as possible and held still until the instrument reads the bar code printed on the card. The operator will have approximately 30 seconds within which to complete the scanning process or the instrument will default to manual entry and display the **“Enter Subject Name (L, F, M)”** message. The instrument will acknowledge that a successful scan of the subject’s license was

	Originally Adopted: 07/13/2006	Revision #: 1.0 Revision Effective Date: 07/17/2006
ALL PRINTED COPIES ARE UNCONTROLLED AND MAY NOT BE COMPLETE		Page 13 of 50

OREGON STATE POLICE IMPLIED CONSENT PROGRAM

INTOXILYZER 8000 OPERATOR'S GUIDE
2.0 STEP ONE – PREPARING TO CONDUCT A TEST

completed by alerting the operator with an audible tone. The instrument will then proceed to the “Review Data (Y/N)?” message (see page 15).

Entering Driver's License Data Manually

From the “Scan Subject License or Press Enter” message, the operator may choose to enter license information manually by pressing the “Enter” key on the instrument's keyboard. An operator may choose to do this in the event that the subject is unlicensed, has lost or misplaced their license, or in the event that the bar code printed on the license is unreadable by the instrument's bar code scanner. The instrument will acknowledge the operator's selection to manually enter license information by proceeding to the “Enter Subject Name (Last, First, M)” message.



The operator should type the name of the subject just as it is to be printed on the final Completed Test Report. As the operator enters information on the keyboard, the information will be displayed on the second line of the instrument's display. Generally, name information is entered in a uniform format similar to that used by the LEDS (Law Enforcement Data System) reporting system (last name, first name, middle name or initial), however, the subject name field is not required and no data need be entered for the instrument to proceed through the testing sequence. In some instances, the LEDS format may not be appropriate and the operator may choose to deviate from this format. Information entered into the instrument will be printed on the Test Report in WYSIWYG (What You See Is What You Get) format. The operator must confirm the information entered by pressing the “Enter” key on the instrument's keyboard. The instrument will then proceed to the “Enter Subject DOB (MM/DD/YYYY)” message.



The operator should type the Date of Birth (DOB) of the driver in mm/dd/yyyy format and confirm the information by pressing the “Enter” key on the instrument's keyboard. As the operator enters information on the keyboard, the information will be displayed on the second line of the instrument's display. The subject DOB field is a required field, however, if the DOB is unknown, it need not be correct for the instrument to proceed through the testing sequence. A false DOB can be used (i.e., "01/01/1901").

	Originally Adopted: 07/13/2006	Revision #: 1.0 Revision Effective Date: 07/17/2006
ALL PRINTED COPIES ARE UNCONTROLLED AND MAY NOT BE COMPLETE		Page 14 of 50

OREGON STATE POLICE IMPLIED CONSENT PROGRAM

INTOXILYZER 8000 OPERATOR'S GUIDE
2.0 STEP ONE – PREPARING TO CONDUCT A TEST

The instrument will acknowledge the entry of DOB information by proceeding to the “**Enter Subject ID #**” message:

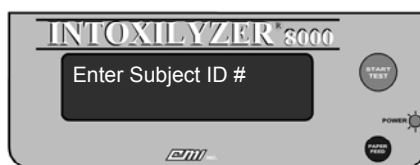

The operator should type the identification number for the subject and confirm the information by pressing the “Enter” key on the instrument’s keyboard. As the operator enters information on the keyboard, the information will be displayed on the second line of the instrument’s display. The form of identification can be obtained from any valid form of identification issued by either a federal or state issuing authority. The subject ID field is not required and no data need be entered for the instrument to proceed through the testing sequence. The instrument will acknowledge the entry of subject identification number information by proceeding to the “**Enter State of Issue**” message:

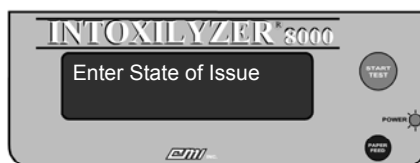

The operator should type the two (2) letter designation for the jurisdiction responsible for issuing the form of identification used in the above section and confirm the information by pressing the “Enter” key on the instrument’s keyboard. As the operator enters information on the keyboard, the information will be displayed on the second line of the instrument’s display. For documents issued by the US government (i.e., Social Security Cards, etc.), the operator may enter “US” for this field. The state of issue field is not required and no data need be entered for the instrument to proceed through the testing sequence. The instrument will acknowledge the entry of subject identification number information by proceeding to the “**Review Data (Y/N)?**” message:

Reviewing Data

Once all pre-test data has either been scanned or entered manually into the instrument, the instrument will display the “**Review Data (Y/N)?**” message.

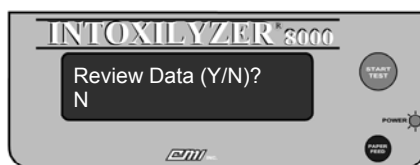

Originally Adopted: 07/13/2006

Revision #: 1.0
Revision Effective Date: 07/17/2006

OREGON STATE POLICE IMPLIED CONSENT PROGRAM

INTOXILYZER 8000 OPERATOR'S GUIDE
2.0 STEP ONE – PREPARING TO CONDUCT A TEST

The operator may choose “Y” to review the subject information data entered into the instrument or press “N” to proceed to the testing sequence. The operator must confirm the selection by pressing the “Enter” key on the instrument’s keyboard. If “Y” is selected, the instrument will separately display the Subject Name, Subject DOB, Subject ID #, and State of Issue. The operator can not edit the operator permit information, but may edit the subject information if necessary. After displaying each entry, the operator must accept the information by pressing the “Enter” key on the instrument’s keyboard.

Aborting a Test Sequence

During the testing sequence, an operator may choose to abort the test sequence by selecting one of two alternative methods: a) by pressing the “Start Test” button at any time during the test sequence other than during the breath sampling period(s); or b) by pressing the “A” key on the instrument keyboard.

NOTE: Operators need to exercise care when using the “Start Test” button to abort the test sequence. If an operator mistakenly uses the “Start Test” button to abort a test sequence while the instrument is in the “Please Blow” or breath sampling period, the instrument will record a “Refused” test sequence rather than a “Sequence Aborted” test.

	Originally Adopted: 07/13/2006	Revision #: 1.0 Revision Effective Date: 07/17/2006
ALL PRINTED COPIES ARE UNCONTROLLED AND MAY NOT BE COMPLETE		Page 16 of 50

INTOXILYZER 8000 OPERATOR'S GUIDE
3.0 STEP TWO - CONDUCTING A BREATH TEST

3.0 STEP TWO – CONDUCTING A BREATH TEST

Testing Sequence

Once the permit and license information has been entered and reviewed, the instrument will proceed to the testing sequence. The steps of the testing sequence are outlined below and are described in more detail later in the chapter. The instrument's testing sequence is as follows:

- Pre-Test Observation Period
- Air Blank
- Diagnostic Test
- Air Blank
- Breath Sample
- Air Blank
- Continued Observation Period
- Air Blank
- Breath Sample
- Air Blank
- Control Sample
- Air Blank
- Comment Lines
- Printing of Test Report

The "Ready in 00:XX" message

Depending on the amount of time necessary for the operator to complete the data entry section of preparing to conduct a breath test, the instrument may display the "Ready in 00:XX" message with a timer that will count down the period of time needed for the instrument to be ready to conduct a breath test. This period of time is generally less than 60 seconds and commonly will be closer to 30 seconds in duration. During this period, the instrument is preparing itself to conduct a test. If the instrument has been recently used, the instrument may not require any preparation time. If desired, the operator can abort the testing sequence by pressing the "Start Test" button. During the "Ready in 00:XX" period, the instrument display will look similar to the figure below:



When the instrument completes the countdown, the instrument will proceed to the first step of the testing sequence.

	Originally Adopted: 07/13/2006	Revision #: 1.0 Revision Effective Date: 07/17/2006
ALL PRINTED COPIES ARE UNCONTROLLED AND MAY NOT BE COMPLETE		Page 17 of 50

OREGON STATE POLICE IMPLIED CONSENT PROGRAM

INTOXILYZER 8000 OPERATOR'S GUIDE
3.0 STEP TWO - CONDUCTING A BREATH TEST

Air Blank

The instrument will initiate the testing sequence by performing an air blank. The instrument display will display the **"Air Blank"** message and turn on the instrument's internal purge pump for approximately 20 seconds.

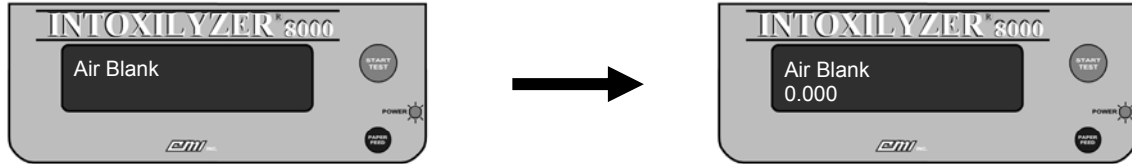

The instrument will draw in room ("ambient") air to purge the sample chamber and breath path of any possible alcohol or other contaminants. If all the parameters are met, the instrument will proceed to the next step. If there is a problem, the instrument will abort the test and display a message of **"Ambient Fail"** on the display and print **"*Invalid Test – Check Ambient Conditions"** on the Test Report (refer to Section 4.0 – Reviewing the Test Report).

Diagnostic Routine

Following the successful completion of the **"Air Blank"**, the instrument will perform a complete diagnostic check on its components and operational standards.

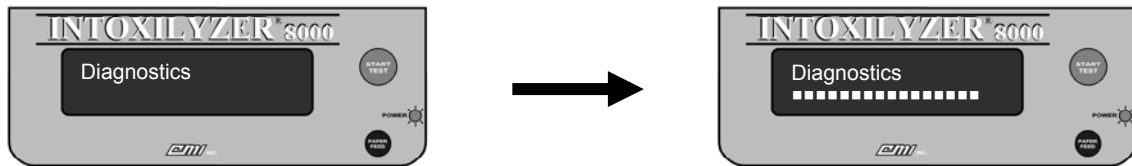

If no operational malfunctions are found, the instrument will display a message of **"Diagnostics Pass"** and then proceed to the next step.



If any malfunctions in the operation of the instrument are detected, the instrument will abort the test displaying a message on the display.

Originally Adopted: 07/13/2006

Revision #: 1.0
Revision Effective Date: 07/17/2006

INTOXILYZER 8000 OPERATOR'S GUIDE
3.0 STEP TWO - CONDUCTING A BREATH TEST

Air Blank

The instrument will next perform another air blank following the successful completion of a Diagnostic Routine. The instrument display will display the **“Air Blank”** message and turn on the instrument's internal purge pump for approximately 20 seconds.

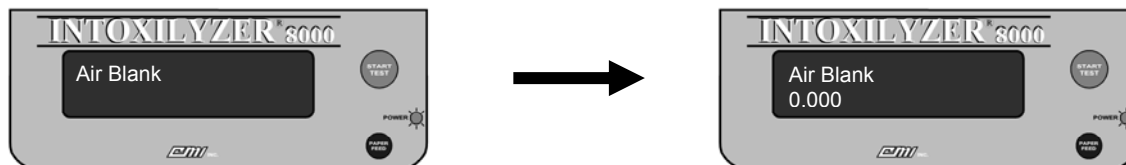

The instrument will draw in room (“ambient”) air to purge the sample chamber and breath path of any possible alcohol or other contaminants. If all the parameters are met, the instrument will proceed to the next step. If there is a problem, the instrument will abort the test and display a message of **“Ambient Fail”** on the display and print **“*Invalid Test – Check Ambient Conditions”** on the Test Report.

Breath Sampling Period

From the **“Air Blank”** message, the instrument will next enter the breath sampling period. The instrument will briefly display a progress bar as a series of rectangular characters (i.e., “■”) and then begin scrolling the message **“Please blow into mouthpiece to activate tone”** across the top line of the instrument's display. At this time the operator takes command of the instrument. The instrument display will look similar to the figure below:

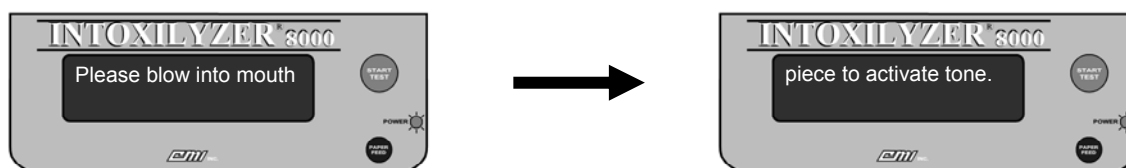

An important factor in collecting an acceptable breath sample is the instructions that are given to the test subject. The following instructions are recommended:

I WANT YOU TO TAKE A DEEP BREATH AND BLOW INTO THE INSTRUMENT WITH ONE LONG, CONTINUOUS BREATH. BLOW WITH SUFFICIENT FORCE TO INITIATE AND MAINTAIN THE AUDIBLE TONE. CONTINUE BLOWING UNTIL I TELL YOU TO STOP. DO YOU UNDERSTAND THESE INSTRUCTIONS?

With these instructions, the operator can control the length of time that the subject delivers the sample, assuring that the sample provided will be the best possible sample. The operator is assured that a proper sample is being provided to the instrument when a continuous audible tone is heard and the instrument displays the **“Please Blow”** message. As the subject continues to blow, several

	Originally Adopted: 07/13/2006	Revision #: 1.0 Revision Effective Date: 07/17/2006
ALL PRINTED COPIES ARE UNCONTROLLED AND MAY NOT BE COMPLETE		Page 19 of 50

OREGON STATE POLICE IMPLIED CONSENT PROGRAM

INTOXILYZER 8000 OPERATOR'S GUIDE
3.0 STEP TWO - CONDUCTING A BREATH TEST

indicator marks will appear across the display. When a "period" is displayed following the "Please blow" message, making the message read "Please Blow.", the instrument has obtained an adequate sample and the operator may instruct the subject to stop blowing.

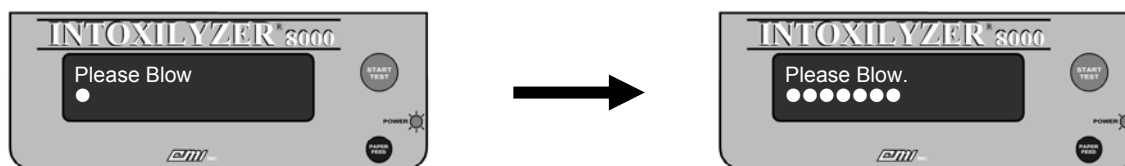

If the subject does not provide an adequate breath sample (i.e., the "period" is not displayed), the instrument will notify the operator by flashing the "Please Blow" message and emitting an audible tone. The operator should re-instruct the subject on how to provide a proper sample and have him/her blow again. If the subject, through a willful act, still does not provide a proper sample, the operator should consider it to be a refusal. If, however, the operator believes that the subject is physically unable to provide an acceptable sample, but the subject evacuated his/her lungs and the sample was the best the subject could give, the operator may allow the instrument to time out. The instrument will display the "Refusal (Y/N)?" message. The operator may select the "Y" key on the instrument keyboard to document a refused test, or select the "N" key on the instrument keyboard to document an "Invalid Test - Deficient Sample" on the Test Report. After approximately one (1) minute, the instrument will automatically time-out and print "Invalid Test – Deficient Sample".

A test for interfering substances is again made during this breath sampling period. If an interfering substance is detected which would affect the breath test reading, the message "Interferent Detected" will be displayed and an error message of "Invalid Test – Interfering Substance Detected" will be printed on the Test Report.

The instrument allows at least three (3) minutes for a test subject to submit an acceptable breath sample (a continuous end-expiratory breath sample resulting in the instrument displaying a "period" at the end of the "Please Blow" message). The instrument will terminate the breath sampling phase before the end of the three minute period if any of the following conditions are met:

1. The subject submits an acceptable sample.

Originally Adopted: 07/13/2006

Revision #: 1.0
Revision Effective Date: 07/17/2006

OREGON STATE POLICE IMPLIED CONSENT PROGRAM

INTOXILYZER 8000 OPERATOR'S GUIDE
3.0 STEP TWO - CONDUCTING A BREATH TEST

- The subject refuses the test and the operator pushes the "Start Test" button or the "R" key on the instrument keyboard to indicate to the instrument the operator's request that the instrument document the refusal. The instrument will emit an alternating audible warning tone and display the message "**Subject Test Refused**".



- An exception to the testing sequence was detected by the instrument such as "***Invalid Test – Interfering Substance Detected**" or "***Invalid Sample – Residual Alcohol Present**".
- The operator aborts the testing sequence by selecting the "A" key on the instrument keyboard.

If the three-minute breath request period lapses without the subject having provided an adequate breath sample, the instrument will indicate one of two messages:

- "***Invalid Test - No Sample Given**" – The person did not blow with sufficient force to activate the audible tone during the three minute request period. The instrument will display the "**No Sample Given**" message accompanied by a low/high alternating tone sounding intermittently for approximately five seconds.



If the operator allows the three minute request period to time out, and no sample was given, the operator should not treat this as a refusal. Instead, the test should be restarted to allow the subject additional time to either submit to the test or refuse to take the test. The operator should retain the Test Report from this test.

- "**Refusal (Y/N)?**" – The person blew with sufficient force to activate the audible tone at least once during the three minute request period, but the sample did not meet the minimum requirements of an adequate breath sample.

Originally Adopted: 07/13/2006

Revision #: 1.0
Revision Effective Date: 07/17/2006

OREGON STATE POLICE IMPLIED CONSENT PROGRAM

INTOXILYZER 8000 OPERATOR'S GUIDE
3.0 STEP TWO - CONDUCTING A BREATH TEST

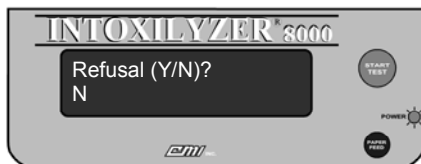

The operator must decide at this point whether the subject has, through some willful act, refused to comply with instructions to provide an acceptable breath sample. If so, the operator should indicate his selection by pressing "Y" on the instrument keyboard. The instrument will display the **"Subject Test Refused"** message.

If the operator has properly instructed the test subject on how to provide the breath sample, and the person has provided a deliberate attempt to meet the requirements of the test, the operator may choose to indicate a **"Deficient Sample"** by pressing "N" on the instrument keyboard to the **"Refusal (Y/N)?"** message. The instrument will display the **"Deficient Sample"** message.



By selecting a **"Deficient Sample"**, the operator has made the determination that the test subject does not have the physical capacity to complete a breath test and is not a suitable candidate to continue with the breath testing process.

If, however, the operator has determined that the subject IS capable of providing a sample, the operator can choose to restart the testing sequence and reinstruct the subject on how to provide a proper sample. An **"*Invalid Test – Deficient Sample"** is not considered to be a completed test unless the operator declares the subject to be physically incapable.

Air Blank

After the breath sampling period is complete, the instrument will perform another **"Air Blank"**. The instrument will display the **"Air Blank"** message and turn on the instrument's internal purge pump for approximately 20 seconds. This will purge the instrument's sample chamber and once again check the operational environment for possible contaminants.

	Originally Adopted: 07/13/2006	Revision #: 1.0 Revision Effective Date: 07/17/2006
ALL PRINTED COPIES ARE UNCONTROLLED AND MAY NOT BE COMPLETE		Page 22 of 50

OREGON STATE POLICE IMPLIED CONSENT PROGRAM

**INTOXILYZER 8000 OPERATOR'S GUIDE
3.0 STEP TWO - CONDUCTING A BREATH TEST**

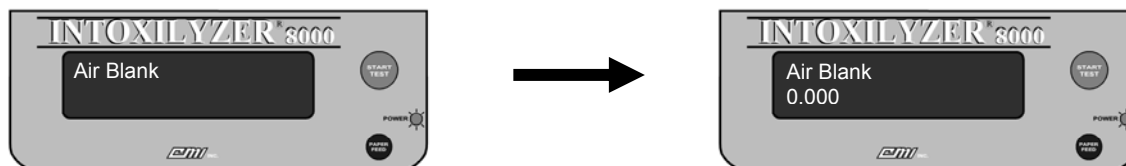

If all the parameters are met, the instrument will proceed to the next step. If there is a problem, the instrument will abort the test and display a message of **“Purge Fail”** on the display and print **“*Invalid Test – Purge Fail”** on the Test Report.

Continued Observation Period

After successfully providing the breath sample, the operator should continue observing the subject to ensure that the subject does not vomit, regurgitate, eat, drink, smoke, chew or take anything orally for an additional period of approximately 2 minutes. This is to continue to ensure that there is no possibility of residual alcohol or mouth contamination causing a result that does not reflect the subject's true blood alcohol concentration. The Intoxilyzer does monitor the breath sample throughout the entire delivery and will automatically abort the test if any abnormalities are detected. By vigilantly continuing the observation period, however, the possibility of residual mouth alcohol contamination is eliminated. The instrument will display the following message and a count-down timer to indicate to the operator the remaining time in the observation period:

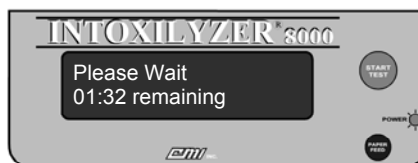

Note: The instrument will start the countdown for the two (2) minute observation period at approximately one (1) minute and thirty-two (32) seconds (01:32 remaining). This is because the two (2) minute observation period begins following the completion of the previous breath sample and concludes at the beginning of the second breath sampling period. Therefore, the duration of approximately 20 seconds utilized during the “Air Blank” performed immediately following the completion of the breath sampling period, and the approximate 20 seconds included in the “Air Blank” preceding the second breath sampling period, are attributed to the total time for the two (2) minute observation period.

The Continued Observation Period will be considered incomplete if:

1. The operator has reason to believe that the subject has taken something by mouth (drinking, smoking, eating, taking medication, etc.), vomited, or regurgitated liquid from the stomach into mouth; or

	Originally Adopted: 07/13/2006	Revision #: 1.0 Revision Effective Date: 07/17/2006
ALL PRINTED COPIES ARE UNCONTROLLED AND MAY NOT BE COMPLETE		Page 23 of 50

OREGON STATE POLICE IMPLIED CONSENT PROGRAM

INTOXILYZER 8000 OPERATOR'S GUIDE
3.0 STEP TWO - CONDUCTING A BREATH TEST

2. The subject, through some willful act, refuses the breath test; or
3. The operator (by pressing the "Start Test" button or pressing the "A" key on the instrument keyboard) or the instrument aborts the testing sequence.

In the event of a discontinued or incomplete Observation Period, the operator should abort the testing sequence, document the reason for halting the testing sequence, and restart the Pre-Test Observation Period. The operator can then retest the subject.

Air Blank

After waiting for approximately two-minutes, the instrument will perform another "Air Blank". The instrument will display the "Air Blank" message and turn on the instrument's internal purge pump for approximately 20 seconds.

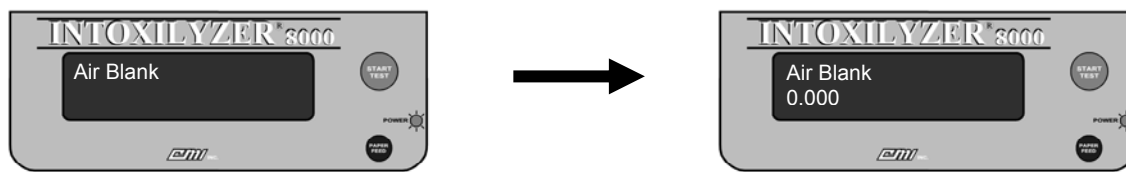

This will purge the instrument's sample chamber and once again check the operational environment for possible contaminants. If all the parameters are met, the instrument will proceed to the next step. If there is a problem, the instrument will abort the test and display a message of "Ambient Fail" on the display and print "Invalid Test – Check Ambient Conditions" on the Test Report.

Breath Sampling Period

Next, the instrument will again enter a breath sampling period. The instrument will briefly display a progress bar as a series of rectangular characters (i.e., "█") and then begin scrolling the message and scroll the message "Please blow into mouthpiece to activate tone." across the instrument display. At this time the operator again takes command of the instrument. The operator should instruct the subject to provide an acceptable breath sample using the same instructions given to the subject previously. The instrument display will look similar to the figure below:

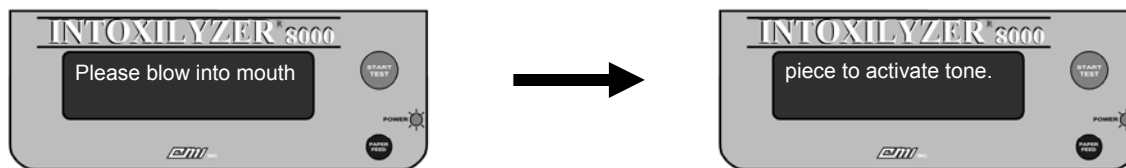

Originally Adopted: 07/13/2006

Revision #: 1.0
Revision Effective Date: 07/17/2006

OREGON STATE POLICE IMPLIED CONSENT PROGRAM

INTOXILYZER 8000 OPERATOR'S GUIDE
3.0 STEP TWO - CONDUCTING A BREATH TEST

As the subject provides a sample, the operator is assured that a proper sample is being provided when a continuous audible tone is heard and the instrument displays the **"Please Blow"** message. As the subject continues to blow, several indicator marks will appear across the display. When a "period" is displayed following the **"Please blow"** message, making the message read **"Please Blow."**, the instrument has obtained an adequate sample and the operator may instruct the subject to stop blowing.

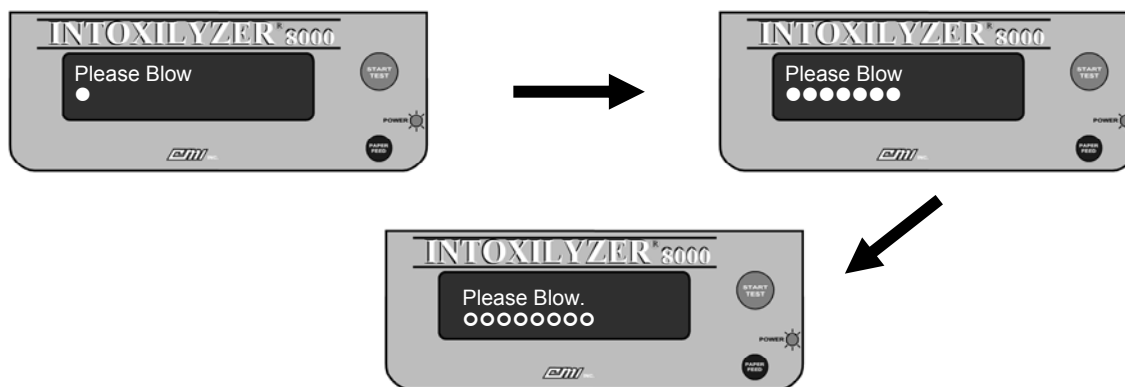

If the subject does not provide an adequate breath sample (i.e., the "period" is not displayed), the instrument will notify the operator by flashing the **"Please Blow"** message and emitting an audible tone. The operator should re-instruct the subject on how to provide a proper sample and have him/her blow again. If the subject, through a willful act, still does not provide a proper sample, the operator should consider it to be a refusal. If, however, the operator believes that the subject is physically unable to provide an acceptable sample, but the subject evacuated his/her lungs and the sample was the best the subject could give, the operator may allow the instrument to time out which would result in an **"*Invalid Test - Deficient Sample"** being printed on the Test Report.

A test for interfering substances is again made during this breath sampling period. If an interfering substance is detected which would affect the breath test reading, the message **"Interferent Detected"** will be displayed and an error message of **"*Invalid Test – Interfering Substance Detected"** will be printed on the Test Report.

The instrument allows at least three (3) minutes for a test subject to submit an acceptable breath sample (a continuous end-expiratory breath sample resulting in the instrument displaying a "period" at the end of the **"Please Blow"** message). The instrument will terminate the breath sampling phase before the end of the three minute period if any of the following conditions are met:

1. The subject submits an acceptable sample.

	Originally Adopted: 07/13/2006	Revision #: 1.0 Revision Effective Date: 07/17/2006
ALL PRINTED COPIES ARE UNCONTROLLED AND MAY NOT BE COMPLETE		Page 25 of 50

OREGON STATE POLICE IMPLIED CONSENT PROGRAM

INTOXILYZER 8000 OPERATOR'S GUIDE
3.0 STEP TWO - CONDUCTING A BREATH TEST

2. The subject refuses the test and the operator pushes the "Start Test" button or the "R" key on the instrument keyboard to indicate to the instrument the operator's request that the instrument document the refusal. The instrument will emit an alternating audible warning tone and display the message "**Subject Test Refused**".



3. An exception to the testing sequence was detected by the instrument such as "***Invalid Test – Interfering Substance Detected**" or "***Invalid Sample – Residual Alcohol Present**".
4. The operator aborts the testing sequence by selecting the "A" key on the instrument keyboard.

If the three-minute breath request period lapses without the subject having provided an adequate breath sample, the instrument will indicate one of two messages:

1. "***Invalid Test - No Sample Given**" – The person did not blow with sufficient force to activate the audible tone during the three minute request period. The instrument will display the "**No Sample Given**" message accompanied by a low/high alternating tone sounding intermittently for approximately five seconds.



If the operator allows the three minute request period to time out, and no sample was given, the operator should not treat this as a refusal. Instead, the test should be restarted to allow the subject additional time to either submit to the test or refuse to take the test. The operator should retain the Test Report from this test.

2. "**Refusal (Y/N)?**" – The person blew with sufficient force to activate the audible tone at least once during the three minute request period, but the sample did not meet the minimum requirements of an adequate breath sample.

Originally Adopted: 07/13/2006

Revision #: 1.0
Revision Effective Date: 07/17/2006

OREGON STATE POLICE IMPLIED CONSENT PROGRAM

INTOXILYZER 8000 OPERATOR'S GUIDE
3.0 STEP TWO - CONDUCTING A BREATH TEST



The operator must decide at this point whether the subject has, through some willful act, refused to comply with instructions to provide an acceptable breath sample. If so, the operator should indicate his selection by pressing "Y" on the instrument keyboard. The instrument will display the **"Subject Test Refused"** message.

If the operator has properly instructed the test subject on how to provide the breath sample, and the person has provided a deliberate attempt to meet the requirements of the test, the operator may choose to indicate a **"Deficient Sample"** by pressing "N" on the instrument keyboard to the **"Refusal (Y/N)?"** message. The instrument will display the **"Deficient Sample"** message. By selecting a **"Deficient Sample"**, the operator has made the determination that the test subject does not have the physical capacity to complete a breath test and is not a suitable candidate to continue with the breath testing process.



By selecting a **"Deficient Sample"**, the operator has made the determination that the test subject does not have the physical capacity to complete a breath test and is not a suitable candidate to continue with the breath testing process.

If, however, the operator has determined that the subject IS capable of providing a sample, the operator can choose to restart the testing sequence and reinstruct the subject on how to provide a proper sample. An **"*Invalid Test – Deficient Sample"** is not considered to be a completed test unless the operator declares the subject to be physically incapable.

Originally Adopted: 07/13/2006

Revision #: 1.0
Revision Effective Date: 07/17/2006

INTOXILYZER 8000 OPERATOR'S GUIDE
3.0 STEP TWO - CONDUCTING A BREATH TEST

Air Blank

After the breath sampling period is complete, the instrument will perform another "Air Blank". The instrument will display the "Air Blank" message and turn on the instrument's internal purge pump for approximately 20 seconds.

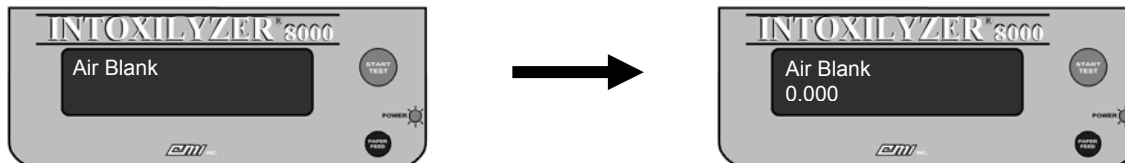

This will purge the instrument's sample chamber and once again check the operational environment for possible contaminants. If all the parameters are met, the instrument will proceed to the next step. If there is a problem, the instrument will abort the test and display a message of "Purge Fail" on the display and print "*Invalid Test – Purge Fail" on the Test Report.

Control Sample

At the successful conclusion of both breath sampling periods, the instrument will perform a control test using an external ethanol breath standard. The instrument will make several "clicking" and "hissing" noises as the gas supply is initiated and terminated. The instrument display will look similar to the following:

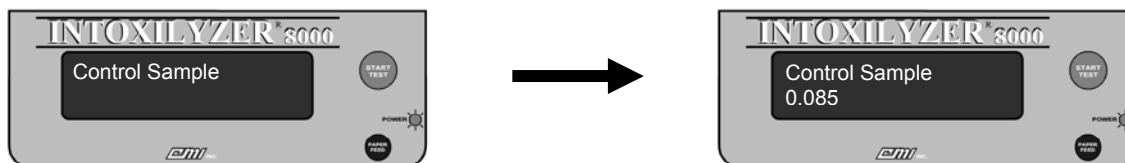

The instrument will analyze a sample from the attached ethanol breath standard and evaluate the accuracy of the instrument. The result of the analysis will be reported as part of the final Test Report. The expected alcohol concentration of the standard is pre-determined and will also be printed on the Test Report. If there is a problem, the instrument will abort the test and display a message of "Control Sample Out of Tolerance" on the display and print "*Invalid Test – Control Sample Out of Tolerance" on the Test Report.

INTOXILYZER 8000 OPERATOR'S GUIDE
3.0 STEP TWO - CONDUCTING A BREATH TEST

Air Blank

After the instrument has accepted the subject breath sample, the instrument will perform another “**Air Blank**”. The instrument will display the “**Air Blank**” message and turn on the instrument’s internal purge pump for approximately 20 seconds.

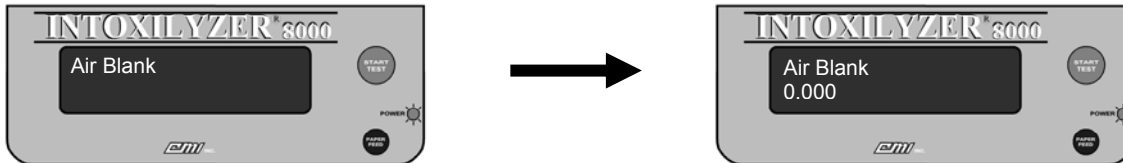

This will purge the instrument’s sample chamber and once again check the operational environment for possible contaminants. If all the parameters are met, the instrument will proceed to the next step. If there is a problem, the instrument will abort the test and display a message of “**Purge Fail**” on the display and print “***Invalid Test – Purge Fail**” on the Test Report.

Comment Lines

Immediately prior to printing the Test Report, the operator will be given the opportunity to enter comments into the “Comments” section of the report. This information will then appear on the final printed version of the Test Report. The instrument will prompt the operator by first displaying a message of “**Add Comments (Y/N)?**”.



By selecting “N” on the instrument keyboard, the instrument will proceed directly to printing of the Test Report. A selection of “Y” on the instrument keyboard will allow the operator to enter additional information into the Test Report. The instrument will display three (3) comment messages, starting with “**Comment Line 1**”:

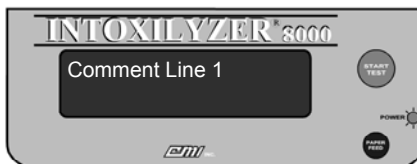

The comments section has a maximum length of 221 characters divided between the three comment lines. After reaching the end of “**Comment Line 1**”, the instrument will display “**Comment Line 2**” followed by “**Comment Line 3**” before proceeding to the next step.

	Originally Adopted: 07/13/2006	Revision #: 1.0 Revision Effective Date: 07/17/2006
ALL PRINTED COPIES ARE UNCONTROLLED AND MAY NOT BE COMPLETE		Page 29 of 50

OREGON STATE POLICE IMPLIED CONSENT PROGRAM

INTOXILYZER 8000 OPERATOR'S GUIDE
3.0 STEP TWO - CONDUCTING A BREATH TEST

Printing of the Test Report

The final phase of the analysis is the printing of the Test Report. The Intoxilyzer 8000 gives a printed record of the serial number and location of the instrument, test procedure, test result, and the date and time of the test.



The operator can be assured that all operational parameters of the test were met because the instrument printed a completed Test Report. If at any time during the testing sequence there had been an exception to the testing sequence, a malfunction, or an error, the test would have been aborted and the instrument would not have printed a completed Test Report. This Test Report will also contain the test subject's name and DOB, the operator's name and permit number and space for remarks or handwritten information deemed pertinent by the operator.

A **Completed Test Report** is one which indicates a breath test result, a refusal, or the presence of an interfering substance. An **Incomplete Test Report** is one which does not indicate a test result, a refusal, or the presence of an interfering substance and will instruct the operator to take some sort of corrective action.

The instrument will provide three (3) copies of the Test Report for the operator to distribute. If additional copies are needed, the operator may re-print a copy of the report either at the time of the test, or anytime up until the instrument's memory is downloaded by the Department of State Police (refer to **Section 4.0 – Reviewing the Test Report**). To reprint the Test Report at the time of the test, the operator should press the "Y" key on the keyboard when the instrument displays the **"Reprint (Y/N)?"** message:



If no action is taken by the operator, the instrument will return to the **"Ready to Start"** message after approximately thirty (30) seconds.

	Originally Adopted: 07/13/2006	Revision #: 1.0 Revision Effective Date: 07/17/2006
ALL PRINTED COPIES ARE UNCONTROLLED AND MAY NOT BE COMPLETE		Page 30 of 50

OREGON STATE POLICE IMPLIED CONSENT PROGRAM

INTOXILYZER 8000 OPERATOR'S GUIDE
3.0 STEP TWO - CONDUCTING A BREATH TEST

Subject Sample Agreement

As part of the testing sequence, the instrument will make a determination as to whether or not the subject breath samples provided were acceptable (i.e., of proper flow rate, duration, and volume) and whether the samples provided were in agreement (i.e., of similar alcohol concentration) with one another. This determination is done automatically by the instrument.

If the operator receives a Completed Test Report containing a numerical Test Result, the operator can be assured that the breath samples provided by the subject were both acceptable to the instrument and in agreement with one another. The value reported by the instrument will be lower value of the two subject samples provided truncated to two-digits (e.g., 0.089 %BAC will be reported as 0.08 %BAC).

If there is a problem, the instrument will abort the test and display a message of **"Sample Corr. Fail"** on the display and print **"*Invalid Test – Subject Sample Correlation Failure"** on the Test Report.

Operators can refer to OAR 257-030-0140 for additional information regarding Subject Sample Agreement requirements utilized by the Intoxilyzer 8000 instrument.

Originally Adopted: 07/13/2006

Revision #: 1.0
Revision Effective Date: 07/17/2006

OREGON STATE POLICE IMPLIED CONSENT PROGRAM

**INTOXILYZER 8000 OPERATOR'S GUIDE
4.0 STEP THREE - REVIEWING THE TEST REPORT**

4.0 STEP THREE – REVIEWING THE TEST REPORT

The Test Report

Once the testing sequence is completed, the instrument will print a final Test Report. The report is characterized by the statement “**Analytical Report**” on the header of the document and contains all of the information from the testing sequence. Generally, the Test Report will contain the following information:

1. The testing location.
2. The date of the test.
3. The serial number of the instrument used.
4. The subject's name, date of birth, license number, and state of issue.
5. The test method steps, the intermediary results of each step, the status of each step, and the time each step was initiated.
6. The final result of the test.
7. Any additional information for the operator.
8. Any “**Suggested Corrective Action**” information would appear in this location.
9. The operator's name, permit number, and the OAR reference to the approved testing method.
10. The statement affirming that the operator has been trained to operate the Intoxilyzer 8000 using the approved testing method.
11. Any additional comments or observations made by the operator.

OREGON DEPARTMENT OF STATE POLICE
FORENSIC SERVICES DIVISION
ANALYTICAL REPORT

TEST DATE: 07/13/2006

INSTRUMENT: CMI INTOXILYZER ALCOHOL ANALYZER MODEL 8000
SN: 80-001839 TEST LOCATION: FORENSIC SERVICES DIVISION

SUBJECT NAME: DOE, JOHN Q.
SUBJECT LICENSE #: OR 123456
SUBJECT DOB: 02/17/1944

Test	%BAC	Status	Time
Air Blank	0.000	PASS	12:05 PDT
Diagnostics	OK	PASS	12:05 PDT
Air Blank	0.000	PASS	12:06 PDT
Subject Sample	0.081	OBTAINED	12:06 PDT
Air Blank	0.000	PASS	12:07 PDT
Air Blank	0.000	PASS	12:09 PDT
Subject Sample	0.079	OBTAINED	12:10 PDT
Air Blank	0.000	PASS	12:10 PDT
Control Sample	0.084	PASS	12:10 PDT
Air Blank	0.000	PASS	12:11 PDT

** EXPECTED VALUE FOR CONTROL: 0.085 %BAC **

TEST RESULT: 0.07 %BAC

ADDITIONAL INSTRUCTIONS: Any observations made by the operator during the testing sequence may be recorded in the comments section below.

NOTE: If the operator has reason to believe that the person arrested has been driving while under the influence of a controlled substance, an inhalant or any combination of an inhalant, a controlled substance and intoxicating liquor, the operator should consider contacting a Drug Recognition Evaluator.

OPERATOR'S NAME: OPERATOR, JMA
OPERATOR'S PERMIT #: 111111
TEST METHOD: OAR 257-030-0130

The above-named individual has satisfactorily met the requirements of ORS §13.160 in the chemical analysis of a person's breath and is approved to operate the above listed equipment using the above listed method as specified by the Department of State Police.

COMMENTS:

Test Reports are divided into two categories: Complete Test Reports and Incomplete Test Reports.

Complete Test Reports

Complete Test Reports will contain one of three results in the Test Result area of the report:

	Originally Adopted: 07/13/2006	Revision #: 1.0 Revision Effective Date: 07/17/2006
ALL PRINTED COPIES ARE UNCONTROLLED AND MAY NOT BE COMPLETE		Page 32 of 50

OREGON STATE POLICE IMPLIED CONSENT PROGRAM

INTOXILYZER 8000 OPERATOR'S GUIDE
4.0 STEP THREE - REVIEWING THE TEST REPORT

1. If the subject submitted to the test, the instrument will print the numerical result obtained from the analysis in the Test Result location. The result will be printed as a two-digit number followed by the measurement units (i.e., "0.14 %BAC").
2. If the subject refused the test and the operator pushes the "Start Test" button or the "R" key on the instrument keyboard, the instrument will print "Refused" in the Test Result location.
3. If the instrument detected an interfering substance in the person's breath sample, the instrument will print "Interferent Detected" in the Test Result location.

Complete Test Reports should be reviewed by the operator. This way, the operator is certain the testing sequence was successful. The Test Result value reported by the instrument on the Completed Test Report will be lower value of the two subject samples provided truncated to two-digits (e.g., 0.089 %BAC will be reported as 0.08 %BAC).

Incomplete Test Reports

Incomplete Test Reports can be differentiated from Complete Test Reports in several different ways:

1. The Test Result will not contain any numerical information, a refusal, or an interfering substance detected statement.
2. The instrument will print a statement clarifying the message contained in the Test Result location immediately underneath the Test Result location in the section titled "Additional Comments". This clarification message will begin with the statement "*Invalid Test" or "*Invalid Sample" followed by additional descriptive information.
3. If appropriate, the instrument will also print a "Suggested Corrective Action" statement to be read and acted on by the operator.

Incomplete Test Reports should be reviewed by the operator. The Suggested Corrective Action statement on the Test Report will often contain the necessary information for the operator to re-initiate the testing sequence and obtain a Complete Test Report.

Common Exception Messages:

The Intoxilyzer 8000 breath alcohol analyzer system is a micro-processor controlled breath alcohol testing device that includes the capability of monitoring its internal systems during a test sequence. As a result, the instrument is able to alert the operator whenever a condition that might affect the result of a breath test occurs. The Intoxilyzer 8000 instrument is designed to only allow a test result to be reported when no exceptions have occurred during the entire testing sequence. Otherwise, the instrument will alert the operator that an exception has occurred by displaying and printing one or more of the following messages:

	Originally Adopted: 07/13/2006	Revision #: 1.0 Revision Effective Date: 07/17/2006
ALL PRINTED COPIES ARE UNCONTROLLED AND MAY NOT BE COMPLETE		Page 33 of 50

INTOXILYZER 8000 OPERATOR'S GUIDE
4.0 STEP THREE - REVIEWING THE TEST REPORT

Interfering Substance Detected

This exception will occur when a substance other than alcohol (i.e., acetone, toluene, etc.) was detected in the breath sample. The subject may be suffering from a dangerous medical condition. The instrument will display “**Interferent Detected**” and print “***Invalid Test – Interfering Substance Detected**”. The test is complete and should not be restarted.

In addition, the following suggested corrective action is provided: 1) The operator should discontinue the Implied Consent process. 2) Ask the subject about diabetes, fasting, and solvent exposure. If diabetic, consider EMS assistance. 3) Consider requesting a voluntary blood sample from the subject or obtain a warrant. 4) Any observations made by the Operator during the testing sequence may be recorded in the comments section.

Improper Sample

This exception will occur when a subject blows into the mouthpiece at an improper time during the testing sequence. The instrument will display “**Improper Sample**” and print “***Invalid Test – Improper Sample**”. The test is not complete and can be restarted.

In addition, the following suggested corrective action is provided: 1) The operator should consider re-instructing the subject on how to provide a proper breath sample. 2) Use a new mouthpiece and restart the test. 3) Continue the test until the subject properly submits to or refuses the test. 4) Any observations made by the Operator during the testing sequence may be recorded in the comments section.

Check Ambient Conditions

This exception will occur when alcohol, or a contaminant, is being introduced into the sample chamber from the surrounding room air during the “Air Blank”. The instrument will display “**Ambient Fail**” and print “***Invalid Test – Check Ambient Conditions**”. The test is not complete and can be restarted.

In addition, the following suggested corrective action is provided: 1) The operator should consider removing any contaminants from the area (to include the subject, if necessary). 2) Use a new mouthpiece and restart the test. 3) Continue the test until the subject properly submits to or refuses the test. 4) Any observations made by the Operator during the testing sequence may be recorded in the comments section.

	Originally Adopted: 07/13/2006	Revision #: 1.0 Revision Effective Date: 07/17/2006
ALL PRINTED COPIES ARE UNCONTROLLED AND MAY NOT BE COMPLETE		Page 34 of 50

OREGON STATE POLICE IMPLIED CONSENT PROGRAM

INTOXILYZER 8000 OPERATOR'S GUIDE
4.0 STEP THREE - REVIEWING THE TEST REPORT

Purge Fail

This exception occurs when the instrument was unable to purge the sample cell after running a breath test. This may be due to the purge pump not operating or the breath path being obstructed. The instrument will display “**Purge Fail**” and print “***Invalid Test – Purge Fail**”. The test is not complete and can be restarted.

In addition, the following suggested corrective action is provided: 1) The operator should consider removing the mouthpiece from the breath tube and checking for any obvious obstructions. 2) Use a new mouthpiece and restart the test. 3) If the instrument gives an additional exception message, consider placing the instrument out of service by placing an “Intoxilyzer Out Of Service” form on the instrument and reporting the problem to the OSP Regional Dispatch Center at 1-800-292-6517. 4) Leave the instrument power on and consider locating an alternative testing location. 5) Any observations made by the Operator during the testing sequence may be recorded in the comments section.

Subject Test Refused

This exception occurs when the operator terminates the testing sequence because the subject refused to continue. The instrument will display “**Subject Test Refused**” and print “***Subject Test Refused**”. The test is complete and should not be restarted unless terminated in error by the operator. If the test was terminated in error, the test may be restarted by the operator.

In addition, the following suggestion is provided: Any observations made by the Operator during the testing sequence may be recorded in the comments section.

Note: A Test Report indicating “***Subject Test Refused**” is not required to document a refusal.

No Sample Given

This exception occurs when the subject did not blow hard enough into the instrument to activate the audible tone during the breath sampling period. The instrument will display “**No Sample Given**” and print “***Invalid Test – No Sample Given**”. The test is not complete and can be restarted.

In addition, the following suggested corrective action is provided: 1) The operator should consider re-instructing the subject on how to provide a proper breath sample. 2) If the operator is continuing the testing process, restart the test. 3) Continue the test until the subject properly submits to or refuses the test. 4) Any observations made by the Operator during the testing sequence may be recorded in the comments section.

Residual Alcohol Present

This exception occurs when residual alcohol was detected in the subject's mouth or upper respiratory tract. This could be the result of recent consumption of alcohol or having vomited or

	Originally Adopted: 07/13/2006	Revision #: 1.0 Revision Effective Date: 07/17/2006
ALL PRINTED COPIES ARE UNCONTROLLED AND MAY NOT BE COMPLETE		Page 35 of 50

OREGON STATE POLICE IMPLIED CONSENT PROGRAM

INTOXILYZER 8000 OPERATOR'S GUIDE
4.0 STEP THREE - REVIEWING THE TEST REPORT

regurgitated liquid from the stomach into the mouth. The instrument will display **“Residual Alcohol Present”** and print **“*Invalid Sample – Residual Alcohol Present”**. The test is not complete and can be restarted.

In addition, the following suggested corrective action is provided: 1) The operator should consider checking the subject's mouth. 2) Conduct another pre-test wait/observation period of at least 15 minutes. 3) Use a new mouthpiece and restart the test. 4) Continue the test until the subject properly submits to or refuses the test. 5) Any observations made by the Operator during the testing sequence may be recorded in the comments section.

RFI Detected

This exception occurs when a radio or cellular phone transmission is detected near the instrument. The instrument will display **“RFI Detected”** and print **“*Invalid Test – RFI Detected”**. The test is not complete and can be restarted.

In addition, the following suggested corrective action is provided: 1) The operator should consider removing the radio frequency transmission source from the vicinity of the instrument. 2) Use a new mouthpiece and restart the test. 3) If the instrument gives an additional exception message, consider placing the instrument out of service by placing an “Intoxilyzer Out Of Service” form on the instrument and reporting the problem to the OSP Regional Dispatch Center at 1-800-292-6517. 4) Leave the instrument power on and consider locating an alternative testing location. 5) Any observations made by the Operator during the testing sequence may be recorded in the comments section.

Unstable Signal

This exception occurs when the instrument could not obtain a stable reference during the testing sequence. The instrument will display **“Unstable Signal”** and print **“*Invalid Test – Unstable Signal”**. The test is not complete and can be restarted.

In addition, the following suggested corrective action is provided: 1) The operator should check for any obvious reason(s) for the condition (i.e., did the subject blow at the wrong time?) 2) Use a new mouthpiece and restart the test. 3) If the instrument gives an additional exception message, consider placing the instrument out of service by placing an “Intoxilyzer Out Of Service” form on the instrument and reporting the problem to the OSP Regional Dispatch Center at 1-800-292-6517. 5) Leave the instrument power on and consider locating an alternative testing location. 6) Any observations made by the Operator during the testing sequence may be recorded in the comments section.

Originally Adopted: 07/13/2006

Revision #: 1.0
Revision Effective Date: 07/17/2006

INTOXILYZER 8000 OPERATOR'S GUIDE
4.0 STEP THREE - REVIEWING THE TEST REPORT

Subject Sample Correlation Failure

This exception occurs when the subject did not provide two similar valid breath samples. This could be a result of improper breath sample delivery or residual alcohol in the subject's upper respiratory tract. The instrument will display "**Sample Corr. Fail**" and print "***Invalid Test – Subject Sample Correlation Failure**". The test is not complete and can be restarted.

In addition, the following suggested corrective action is provided: 1) The operator should consider checking the subject's mouth. 2) Conduct another pre-test wait/observation period of at least 15 minutes. 3) Consider re-instructing the subject on how to provide a proper breath sample. 4) Use a new mouthpiece and restart the test. 5) Continue the test until the subject properly submits to or refuses the test. 6) Any observations made by the Operator during the testing sequence may be recorded in the comments section.

Sequence Aborted by Operator

This exception occurs when the operator aborts the testing sequence. The instrument will display "**Sequence Aborted**" and print "***Invalid Test – Sequence Aborted by Operator**". The test is not complete and can be restarted.

In addition, the following suggested corrective action is provided: 1) If the test was terminated in error, the test may be restarted by the operator. 2) Any observations made by the Operator during the testing sequence may be recorded in the comments section.

Range Exceeded

This exception occurs when the test result was higher than 0.60 %BAC. This could be due to a high concentration of residual alcohol in the subject's mouth or upper respiratory tract from recent consumption of alcohol or having vomited or regurgitated liquid from the stomach into the mouth. The instrument will display "**Range Exceeded**" and print "***Invalid Sample – Range Exceeded**". The test is not complete and can be restarted.

In addition, the following suggested corrective action is provided: 1) The operator should consider checking the subject's mouth. 2) Conduct another pre-test wait/observation period of at least 15 minutes. 3) Use a new mouthpiece and restart the test. 4) Continue the test until the subject properly submits to or refuses the test. 5) Any observations made by the Operator during the testing sequence may be recorded in the comments section.

Control Out of Tolerance

This exception occurs when the result obtained by the instrument during the testing of the external ethanol breath standard is out of tolerance. The instrument will display "**Control Outside Tolerance**" and print "***Invalid Test – Control Out of Tolerance**". The test is not complete and can be restarted.

	Originally Adopted: 07/13/2006	Revision #: 1.0 Revision Effective Date: 07/17/2006
ALL PRINTED COPIES ARE UNCONTROLLED AND MAY NOT BE COMPLETE		Page 37 of 50

OREGON STATE POLICE IMPLIED CONSENT PROGRAM

INTOXILYZER 8000 OPERATOR'S GUIDE
4.0 STEP THREE - REVIEWING THE TEST REPORT

In addition, the following suggested corrective action is provided: 1) The operator should consider removing any contaminants from the area (to include the subject, if necessary). 2) The operator may also consider checking the instrument's connection to the standard delivery system on the right-hand side of the instrument. 3) Use a new mouthpiece and restart the test. 4) If the instrument gives an additional exception message, consider placing the instrument out of service by placing an "Intoxilyzer Out Of Service" form on the instrument and reporting the problem to the OSP Regional Dispatch Center at 1-800-292-6517. 5) Leave the instrument power on and consider locating an alternative testing location. 6) Any observations made by the Operator during the testing sequence may be recorded in the comments section.

Diagnostic Failure

This exception occurs when the instrument fails the Diagnostic routine. The instrument displays "**Diagnostic Fail**" and prints "***Invalid Test – Diagnostic Fail**". The test is not complete and can be restarted.

In addition, the following suggested corrective action is provided: 1) The operator should check for any obvious reason for the condition (i.e., did the subject blow at the wrong time?) 2) Use a new mouthpiece and restart the test. 3) If the instrument gives an additional exception message, consider placing the instrument out of service by placing an "Intoxilyzer Out Of Service" form on the instrument and reporting the problem to the OSP Regional Dispatch Center at 1-800-292-6517. 5) Leave the instrument power on and consider locating an alternative testing location. 6) Any observations made by the Operator during the testing sequence may be recorded in the comments section.

Deficient Sample

This exception occurs when the subject did not blow long enough with sufficient force to properly provide a sample during the breath sample period. The instrument will display "**Deficient Sample**" and print "***Invalid Test – Deficient Sample**". The test is not complete and can be restarted unless the operator determines that the subject is physically incapable of providing a proper sample.

In addition, the following suggested corrective action is provided: 1) The operator should consider re-instructing the subject on how to provide a proper breath sample. 2) If the operator is continuing with the testing process, use a new mouthpiece and restart the test. 3) Continue the test until the subject properly submits to or refuses the test. 4) Any observations made by the Operator during the testing sequence may be recorded in the comments section.

Note: If the subject is physically incapable of completing the breath sample, the operator may choose to stop the testing sequence. If the operator chooses to end the testing process with a "**Deficient Sample**" test result, the Implied Consent suspension process should also be terminated. Without a Completed Test Report, DMV cannot take action against the driver.

	Originally Adopted: 07/13/2006	Revision #: 1.0 Revision Effective Date: 07/17/2006
ALL PRINTED COPIES ARE UNCONTROLLED AND MAY NOT BE COMPLETE		Page 38 of 50

INTOXILYZER 8000 OPERATOR'S GUIDE
4.0 STEP THREE - REVIEWING THE TEST REPORT

Suggested Corrective Action Statements

Suggested corrective action statements are intended to provide the operator with a suggested course of action in response to an instrument exception message. **STRICT ADHERENCE TO SUGGESTED CORRECTIVE ACTION STATEMENTS BY AN OPERATOR IS NEITHER REQUIRED NOR NECESSARY TO CORRECT AN EXCEPTION CONDITION.** Any attempt to suggest that an operator is negligent as a result of failure to perform all steps identified in a Suggested Corrective Action statement is misplaced.

Other Messages Displayed by the Instrument

Tank Pressure Low Change Standard Soon

If the instrument detects that the external ethanol breath standard pressure, measured in Pounds per Square Inch (PSI), is less than approximately 70 PSI, the instrument will display the **“Tank Pressure Low Change Standard Soon”** message. The operator should continue with the testing sequence and notify the agency responsible for hosting the instrument of the warning message.



ID Not Found

If the instrument is unable to verify the permit number and PIN combination entered by the operator when entering a permit number manually, the operator will have three (3) opportunities to correctly enter his/her permit number and PIN combination before the instrument will display the **“ID Not Found”** message. This message means the operator does not have a valid permit number, is not entered into the instrument's internal database, or is using an incorrect permit number and PIN combination.



	Originally Adopted: 07/13/2006	Revision #: 1.0 Revision Effective Date: 07/17/2006
ALL PRINTED COPIES ARE UNCONTROLLED AND MAY NOT BE COMPLETE		Page 39 of 50

INTOXILYZER 8000 OPERATOR'S GUIDE
4.0 STEP THREE - REVIEWING THE TEST REPORT

Incorrect PIN

If the instrument is unable to verify the PIN entered by the operator when entering an operator PIN manually, the instrument will display the **“Incorrect PIN”** message. The operator should verify his or her PIN and attempt to enter the number again. An operator is given three (3) attempts to correctly enter their PIN before the instrument aborts the testing sequence.



Permit Expired

If the operator's permit has expired, the instrument will display the **“Permit Expired”** message. The operator should contact the Oregon State Police Training Coordinator to arrange for a permit renewal application.



Clearance Exceeded

If the operator attempts to perform an operation with the instrument for which they have not been given clearance, the instrument will display the **“Clearance Exceeded”** message. The operator should contact the Oregon State Police to arrange for a Technician to perform the attempted operation or service the instrument.



OREGON STATE POLICE IMPLIED CONSENT PROGRAM

INTOXILYZER 8000 OPERATOR'S GUIDE
4.0 STEP THREE - REVIEWING THE TEST REPORT

Disabled Mode

Oregon State Police Implied Consent Unit personnel have the ability to “disable” the Intoxilyzer 8000 so that the instrument cannot be used by operators. When the instrument is disabled, the instrument will display “**Disabled Mode**” and the date and time:



Other messages

On rare occasions, the instrument may display messages other than those listed in this Guide. When this occurs, contact the Oregon State Police as described in **Section 7.0 – Placing an Instrument Out-of-Service**.

Originally Adopted: 07/13/2006

Revision #: 1.0
Revision Effective Date: 07/17/2006

INTOXILYZER 8000 OPERATOR'S GUIDE
5.0 REPRINTING THE TEST REPORT

5.0 REPRINTING THE TEST REPORT

Requesting Copies of Test Reports

Both Complete and Incomplete Test Reports can be re-printed from the Intoxilyzer 8000 instrument by the operator at anytime up until the instrument's memory is downloaded by the Department of State Police. Afterwards, requests for duplicate Test Reports can be made by contacting the following address:

Oregon State Police Portland Metro Forensic Laboratory
 Toxicology / Implied Consent Section
 13309 SE 84th Avenue, Suite 200
 Clackamas, Oregon 97015
 (503) 451-2230

On-site Reprinting of Test Reports

While on-site, the operator may attempt to re-print Test Report information. From the **“Ready to Start”** message, the operator may select the **“F4”** key on the instrument keyboard. The instrument will acknowledge the operator's action by requesting for the operator to scan his or her operator permit. The instrument will display the following message:



When the instrument displays the **“Scan Operator Permit or Press Enter”** message, the operator may use the instrument's internal bar code scanner to read the bar code printed on an operator permit card.

The card should be held perpendicular to the face of the instrument directly above the keyboard. The card should be kept as flat as possible and held still until the instrument reads the bar code printed on the card. The operator will have approximately 30 seconds within which to complete the scanning process or the instrument will default to manual entry and display the **“Enter Permit #”** message. The instrument will acknowledge that a successful scan of the operator's card was completed by alerting the operator with an audible tone. The instrument will then proceed to the **“Enter Operator PIN”** message.

Entering Permit Data Manually

From the **“Scan Operator Permit or Press Enter”** message, the operator may choose to enter their operator permit information manually by pressing the **“Enter”** key on the instrument's keyboard. An operator may choose to do this in the event that they have forgotten or lost their operator permit card,

	Originally Adopted: 07/13/2006	Revision #: 1.0 Revision Effective Date: 07/17/2006
ALL PRINTED COPIES ARE UNCONTROLLED AND MAY NOT BE COMPLETE		Page 42 of 50

OREGON STATE POLICE IMPLIED CONSENT PROGRAM

INTOXILYZER 8000 OPERATOR'S GUIDE
5.0 REPRINTING THE TEST REPORT

or in the event that the bar code printed on the operator permit card is unreadable by the instrument's bar code scanner. The instrument will acknowledge the operator's selection to manually enter permit information by proceeding to the "Enter Permit #" message.



The operator should type in his or her operator permit number (DPSST number). As the operator enters information on the keyboard, the information will be displayed on the second line of the instrument's display. The operator must then confirm the permit information by pressing the "Enter" key on the instrument's keyboard. **IN ORDER TO REPRINT A TEST REPORT, A VALID OPERATOR PERMIT NUMBER AND PIN COMBINATION MUST BE ENTERED. THE OPERATOR CANNOT CHOOSE TO SKIP THESE STEPS.** If no permit number is entered, the instrument will return to the "Ready to Start" message after approximately 60 seconds have elapsed. The instrument will abort the sequence if an invalid permit number and PIN combination is entered.

Entering an Operator PIN

Upon successfully scanning an operator permit or the manual entry of a valid permit number and operator name, the instrument will proceed to the "Enter Operator PIN" message. The operator should enter his or her Personal Identification Number (PIN) and confirm the information by pressing the "Enter" key on the instrument's keyboard:

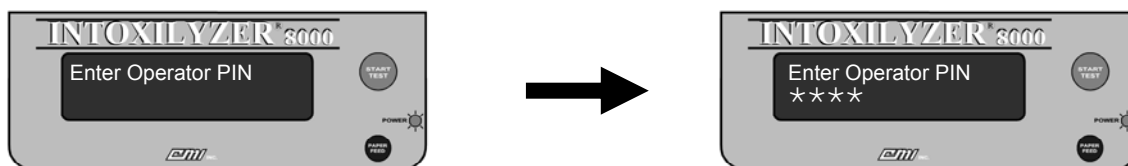

As the operator enters his or her PIN information on the keyboard, an asterisk ("*") character will be displayed on the second line of the instrument's display. The instrument will validate the information provided by the operator and acknowledge that a valid PIN has been entered by proceeding to the Test Report display. If an operator does not enter his/her correct PIN, the instrument will abort the reprint sequence after three (3) unsuccessful attempts are made by the operator. If a PIN is not successfully entered, or no PIN is entered, the instrument will return to the "Ready to Start" message after approximately 60 seconds have elapsed.

From the Test Report display, the operator will be able to view and print a test sequence performed by the operator still resident in the instrument's memory.

	Originally Adopted: 07/13/2006	Revision #: 1.0 Revision Effective Date: 07/17/2006
ALL PRINTED COPIES ARE UNCONTROLLED AND MAY NOT BE COMPLETE		Page 43 of 50

INTOXILYZER 8000 OPERATOR'S GUIDE
5.0 REPRINTING THE TEST REPORT

Selection of a Test Report for Reprinting

In the Test Report display, the instrument will display to the operator all Test Reports performed by the operator still resident in the instruments internal memory by test date, test time, and subject name. Using the "Page Up" and "Page Down" keys on the instrument keyboard, the operator can select the specific Test Report desired for reprinting. Once the desired Test Report is identified, pressing the "Enter" key will initiate the reprint process. It should be noted that only Test Reports generated by the operator will be available to the operator for subsequent reprinting. Test Reports generated by other operators are not accessible to other operators using this reprint function.

The instrument will prompt the operator for the number of reprinted copies desired and then generate the requested Test Reports. The Test Reports that are generated in this manner are identical Test Reports to the original Test Report.

If the Test Report information is not displayed by the instrument during this process, the Test Report may have already been downloaded and removed from the instrument's internal memory. Additional copies of Test Reports can be requested from the Oregon State Police Implied Consent Program

INTOXILYZER 8000 OPERATOR'S GUIDE
6.0 CONDUCTING A JAIL RELEASE TEST

6.0 CONDUCTING A JAIL RELEASE TEST

Conducting a Jail Release Test

A Jail Release Test is an expedited testing sequence that has been developed solely for the purpose of conducting alcohol screening tests on people for the purpose of establishing the presence of alcohol on the breath and not necessarily the actual breath alcohol concentration. This testing sequence is ideal for use in the following situations:

- Testing of minors for purposes of establishing Minor in Possession by Consumption
- Testing of person's for purposes of release from jail detoxification sections.
- Testing of parole and probation participants with no alcohol conditions.
- Testing ordered at the direction of Court personnel (i.e., judge ordered tests).

The "Ready in 00:XX" message

From the "Ready in 00:XX" display, the instrument will display a timer that will count down the period of time needed for the instrument to be ready to conduct a breath test. This period of time is generally less than 60 seconds and commonly will be closer to 30 seconds in duration. During this period, the instrument is preparing itself to conduct a test. If the instrument has been recently used, the instrument may not require any preparation time. If desired, the operator can abort the testing sequence by pressing the "Start Test" button. During the "Ready in 00:XX" period, the instrument display will look similar to the figure below:



When the instrument completes the countdown, the instrument will proceed to the next step of the testing sequence.

Air Blank

The instrument will initiate the jail release testing sequence by performing an air blank. The instrument will display the "Air Blank" message and turn on the instrument's internal purge pump for approximately 20 seconds.

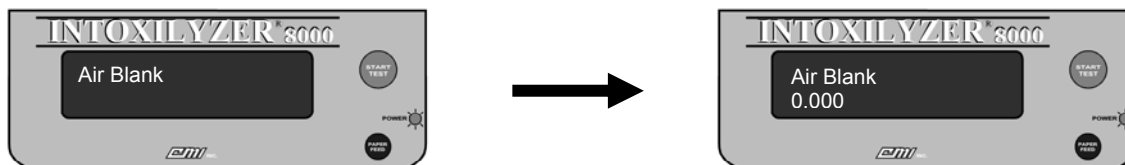

	Originally Adopted: 07/13/2006	Revision #: 1.0 Revision Effective Date: 07/17/2006
ALL PRINTED COPIES ARE UNCONTROLLED AND MAY NOT BE COMPLETE		Page 45 of 50

OREGON STATE POLICE IMPLIED CONSENT PROGRAM

INTOXILYZER 8000 OPERATOR'S GUIDE
6.0 CONDUCTING A JAIL RELEASE TEST

The instrument will draw in room ("ambient") air to purge the sample chamber and breath path of any possible alcohol or other contaminants. If all the parameters are met, the instrument will proceed to the next step. If there is a problem, the instrument will abort the test and display a message of "Ambient Fail" on the display and print "*Invalid" and "*Ambient Fail" on the Test Report.

Breath Sampling Period

From the "Air Blank" message, the instrument will next enter the breath sampling period. The instrument will briefly display a progress bar as a series of rectangular characters (i.e., "■") and then begin scrolling the message "Please blow into mouthpiece to activate tone" across the top line of the instrument's display. At this time the operator takes command of the instrument. The instrument display will look similar to the figure below:

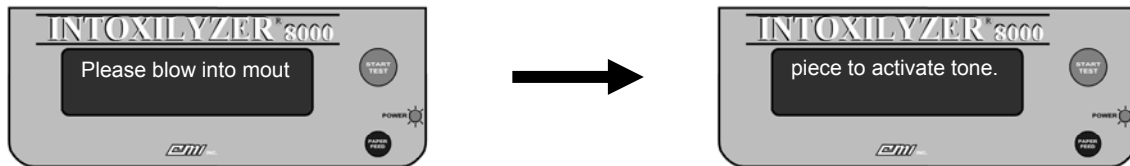

An important factor in collecting an acceptable breath sample is the instructions that are given to the test subject. The following instructions are recommended:

I WANT YOU TO TAKE A DEEP BREATH AND BLOW INTO THE INSTRUMENT WITH ONE LONG, CONTINUOUS BREATH. BLOW WITH SUFFICIENT FORCE TO INITIATE AND MAINTAIN THE AUDIBLE TONE. CONTINUE BLOWING UNTIL I TELL YOU TO STOP. DO YOU UNDERSTAND THESE INSTRUCTIONS?

With these instructions, the operator can control the length of time that the subject delivers the sample, assuring that the sample provided will be the best possible sample. The operator is assured that a proper sample is being provided to the instrument when a continuous audible tone is heard and the instrument displays the "Please Blow" message. As the subject continues to blow, several indicator marks will appear across the display. When a "period" is displayed following the "Please blow" message, making the message read "Please Blow.", the instrument has obtained an adequate sample and the operator may instruct the subject to stop blowing.

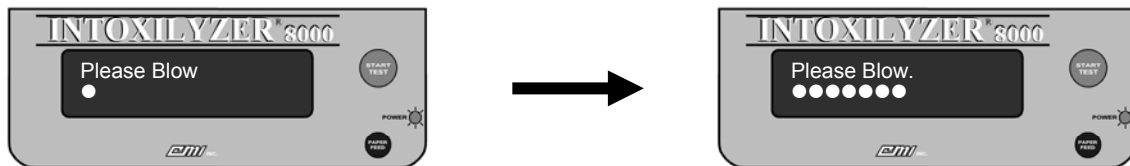

If the subject does not provide an adequate breath sample (i.e., the "period" is not displayed), the instrument will notify the operator by flashing the "Please Blow" message and emitting an audible

Originally Adopted: 07/13/2006

Revision #: 1.0
Revision Effective Date: 07/17/2006

OREGON STATE POLICE IMPLIED CONSENT PROGRAM

INTOXILYZER 8000 OPERATOR'S GUIDE
6.0 CONDUCTING A JAIL RELEASE TEST

tone. The operator should re-instruct the subject on how to provide a proper sample and have him/her blow again. If the subject, through a willful act, still does not provide a proper sample, the operator should consider it to be a refusal. If, however, the operator believes that the subject is physically unable to provide an acceptable sample, but the subject evacuated his/her lungs and the sample was the best the subject could give, the operator may allow the instrument to time out. The instrument will display the "Refusal (Y/N)?" message. The operator may select the "Y" key on the instrument keyboard to document a refused test, or select the "N" key on the instrument keyboard to document an **"*Invalid"** and **"*Deficient Sample"** on the Test Report.

A test for interfering substances is made during the breath sampling period. If an interfering substance is detected which would affect the breath test reading, the message **"Interferent Detected"** will be displayed and an error message of **"*Invalid"** and **"*Interferent Detected"** will be printed on the Test Report.

The instrument allows at least three (3) minutes for a test subject to submit an acceptable breath sample (a continuous end-expiratory breath sample resulting in the instrument displaying a "period" at the end of the **"Please Blow"** message). The instrument will terminate the breath sampling phase before the end of the three minute period if any of the following conditions are met:

1. The subject submits an acceptable sample.
2. The subject refuses the test and the operator pushes the "Start Test" button or the "R" key on the instrument keyboard to indicate to the instrument the operator's request that the instrument document the refusal. The instrument will emit an alternating audible warning tone and display the message **"Subject Test Refused"**.
3. An exception to the testing sequence was detected by the instrument such as **"*Interferent Detected"** or **"*Residual Alcohol Present"**.
4. The operator aborts the testing sequence by selecting the "A" key on the instrument keyboard.

If the three-minute breath request period lapses without the subject having provided an adequate breath sample, the instrument will indicate one of two messages:

1. **"*No Sample Given"** – The person did not blow with sufficient force to activate the audible tone during the three minute request period. The instrument will display the **"No Sample Given"** message accompanied by a low/high alternating tone sounding intermittently for approximately five seconds.

If the operator allows the three minute request period to time out, and no sample was given, the operator should not treat this as a refusal. Instead, the test should be restarted to allow the subject additional time to either submit to the test or refuse to take the test.

	Originally Adopted: 07/13/2006	Revision #: 1.0 Revision Effective Date: 07/17/2006
ALL PRINTED COPIES ARE UNCONTROLLED AND MAY NOT BE COMPLETE		Page 47 of 50

OREGON STATE POLICE IMPLIED CONSENT PROGRAM

INTOXILYZER 8000 OPERATOR'S GUIDE
6.0 CONDUCTING A JAIL RELEASE TEST

2. **“Refusal (Y/N)?”** – The person blew with sufficient force to activate the audible tone at least once during the three minute request period, but the sample did not meet the minimum requirements of an adequate breath sample.

The operator must decide at this point whether the subject has, through some willful act, refused to comply with instructions to provide an acceptable breath sample. If so, the operator should indicate his selection by pressing “Y” on the instrument keyboard. The instrument will display the **“Subject Test Refused”** message.

If the operator has properly instructed the test subject on how to provide the breath sample, and the person has provided a deliberate attempt to meet the requirements of the test, the operator may choose to indicate a **“Deficient Sample”** by pressing “N” on the instrument keyboard to the **“Refusal (Y/N)?”** message. The instrument will display the **“Deficient Sample”** message. By selecting a **“Deficient Sample”**, the operator has made the determination that the test subject does not have the physical capacity to complete a breath test and is not a suitable candidate to continue with the breath testing process.

If, however, the operator has determined that the subject IS capable of providing a sample, the operator can choose to restart the testing sequence and reinstruct the subject on how to provide a proper sample. A **“Deficient Sample”** is not considered to be a completed test unless the operator declares the subject to be physically incapable.

Air Blank

After the breath sampling period is complete, the instrument will perform another **“Air Blank”**. The instrument will display the **“Air Blank”** message and turn on the instrument’s internal purge pump for approximately 20 seconds. This will purge the instrument’s sample chamber and once again check the operational environment for possible contaminants. If all the parameters are met, the instrument will proceed to the next step. If there is a problem, the instrument will abort the test and display a message of **“Purge Fail”** on the display and print **“Invalid”** and **“Purge Fail”** on the Test Report.

Originally Adopted: 07/13/2006

Revision #: 1.0
Revision Effective Date: 07/17/2006

INTOXILYZER 8000 OPERATOR'S GUIDE
7.0 PLACING AN INSTRUMENT OUT-OF-SERVICE

7.0 PLACING AN INSTRUMENT OUT-OF-SERVICE

On rare occasions, an Intoxilyzer 8000 instrument may need to be placed out-of-service by an operator. When this occurs, there are four (4) steps an operator should perform:

1. First, determine exactly what the exception message being reported by the instrument is. This information will be important when reporting the condition to the Oregon State Police regional dispatch center. Also, be sure to perform the suggested correction action that is provided with the exception message. The dispatcher will inquire as to whether the operator has performed this step prior to placing the instrument out-of-service.
2. Second, contact the Oregon State Police regional dispatch center and provide notification of the exception:

OSP Regional Dispatch Center
1-800-292-6517
3. Third, leave the instrument ON and place an Out-of-Service notification placard on the instrument to notify future operators of the condition of the instrument. Do not remove an out-of-service placard unless authorized to do so by a trained technician of the Oregon State Police.
4. Finally, locate an alternative testing location and continue with the testing sequence.

OREGON STATE POLICE IMPLIED CONSENT PROGRAM

**INTOXILYZER 8000 OPERATOR'S GUIDE
APPENDIX A – OPERATOR'S CHECKLIST**

APPENDIX A: OPERATOR'S CHECKLIST

OREGON STATE POLICE FORENSIC SERVICES DIVISION	
INTOXILYZER 8000® OPERATOR'S CHECKLIST	
(Please Print)	
Test Date _____	Arresting Officer (Print) _____
Driver's Name (Last, First, Middle) _____	Arresting Officer's Department _____
OPERATIONAL CHECKLIST	
<input type="checkbox"/> 1. Pre-test observation period: The operator is certain that the subject has not taken anything by mouth (drinking, smoking, eating, taking medications, etc.), vomited, or regurgitated liquid from the stomach into the mouth for at least fifteen (15) minutes before taking the breath test.	
Observer Name (Print): _____ Start time: _____ Stop time: _____ Timepiece used: <input type="checkbox"/> Instrument <input type="checkbox"/> Wristwatch <input type="checkbox"/> Other: _____	
<input type="checkbox"/> 2. When the instrument display indicates "Ready to Start", push "Start Test" button to initiate the testing sequence.	
<input type="checkbox"/> 3. Using either the instrument's bar code scanner or keyboard, enter the operator and subject information requested by the instrument.	
<input type="checkbox"/> 4. After instructing the subject on how to give a proper breath sample, have the subject provide a proper breath sample when "Please blow into mouthpiece to activate tone." appears on display. When the instrument has accepted the sample, continue the required observation period.	
<input type="checkbox"/> 5. When "Please blow into mouthpiece to activate tone." again appears on display, have the subject provide a proper breath sample. When the instrument has accepted the sample, wait for the instrument to complete the testing sequence.	
<input type="checkbox"/> 6. When the instrument display indicates "Comments", enter any appropriate comments regarding the testing sequence.	
<input type="checkbox"/> 7. Remove the test report(s) from the printer.	
Comments: _____ _____ _____	
<1XXXXX/> _____ Instrument Serial #	<20XXXXXXXXXXXXXXXXXXXXXXXXXXXX/> _____ Location
Operator's Name (Print) _____	Operator's Signature _____
Operator's Department _____	Operator's Permit # _____

8000OCL (07.13.2006) Rev 1.0

Originally Adopted: 07/13/2006

Revision #: 1.0
Revision Effective Date: 07/17/2006

